

PALACE

INDUCTION



PATENTED HYDRAULIC BRAKE MECHANISM
 LID REMOVABLE AT 90 DEGREE FOR EASY CLEANING
 LID WILL STOP AT 60 DEGREE (ON THE WAY TO 90 DEGREE)
 WHEN OPENING AND WILL BE SMOOTHLY CLOSED
 LOW 60 DEGREE AUTOMATICALLY
 ANTI-VAPOR-DROP STRUCTURE
 STERNO HEATING POSSIBLE
 TOUGHENED GLASS LID HAS BEEN TESTED WITH 200G
 METAL BALL FREELY FALLING FROM 1.2 M HEIGHT
 18/10 STAINLESS STEEL BODY
 MULTI-LAYER BOTTOM



PALACE ROUND INDUCTION CHAFING DISH

DIMENSION	CAP.	CODE
Ø 45 X H 15 CM	6 LTR	1059640



PALACE ROUND STAND

DIMENSION	CODE
Ø 45 X H 23 CM	1059641



STACKABLE



PORCELAIN INSERT FOR 1059640

	DIMENSION	CODE
A	Ø 39 X H 6.2 CM	1007708
B	Ø 39 X H 6.2 CM	1009591



PALACE ROUND INDUCTION SOUP TUREEN

DIMENSION	CODE
Ø 38 X H 25 CM	1059644



PORCELAIN INSERT FOR 1059644

DIMENSION	CAP.	CODE
Ø 31 X H 17 CM	6 LTR	1009347





STACKABLE



PALACE LARGE SQUARE STAND

DIMENSION	CODE
L 48.6 X W 37.5 X H 23 CM	1059643



PALACE LARGE SQUARE INDUCTION GN 2/3 CHAFING DISH

DIMENSION	CAP.	CODE
L 47 X W 40.5 X H 18 CM	6 LTR	1059642



A



B

PORCELAIN INSERT FOR 1059642

	DIMENSION	CODE
A	GN 2/3 - H 6.5 CM	1032927
B	GN 2/3 - H 6.5 CM	1069058

NEW



SMALL CAPACITY PERFECT FOR COFFEE BREAKS



PALACE SMALL SQUARE INDUCTION GN1/2 CHAFING DISH

DIMENSION	CAP.	CODE
L 46.5 X W 31.5 X H 18 CM	4 LTR	1067524



STACKABLE



PALACE SMALL SQUARE STAND

DIMENSION	CODE
L 39.9 X W 37.7 X H 23 CM	1067525



A



B

PORCELAIN INSERT FOR 1067524

	DIMENSION	CODE
A	GN 1/2 - H 6.5 CM	1007706
B	GN 1/2 - H 6.5 CM	1069056

NEW



NEW

NEOFUSION PORCELAIN INSERT FOR 1067524

	DIMENSION	CAP.	CODE
BRIGHT RED	GN 1/2 - H 6.5 CM	3.3 LTR	1064449
WHITE	GN 1/2 - H 6.5 CM	3.3 LTR	1064493
BLACK	GN 1/2 - H 6.5 CM	3.3 LTR	1064593
GREY	GN 1/2 - H 6.5 CM	3.3 LTR	1064641



STAR

INDUCTION

STOP AT 60 OR 90 DEGREE
ANTI-VAPOR DROP STRUCTURE
STAINLESS STEEL
HYDRAULIC BRAKE MECHANISM
GLASS LID



CHAFING DISH SHOWN WITH STAND



STAR ROUND INDUCTION CHAFING DISH WITH SPOON HOLDER

DESCRIPTION	DIMENSION	CAP.	CODE
ROUND CHAFING DISH WITH SPOON HOLDER	Ø 47CM X H 20 CM	6 LTR	1059645
STAND FOR 1059645	L 31XW 31CM X H16 CM		1059646



PORCELAIN INSERT FOR 1059645

	DIMENSION	CODE
A	Ø 39 CM X H 6.2 CM	1007708
B	Ø 39 CM X H 6.2 CM	1009591



INDUCTION HOB & HEATER
REFER TO PAGE 298



pro.mundi



**STAR SQUARE INDUCTION
CHAFING DISH WITH SPOON HOLDER**

DIMENSION	CAP.	CODE
L 49 X W 43.5 X H 21 CM	6 LTR	1065165



A



B

■ PORCELAIN INSERT FOR 1065165

	DIMENSION	CODE
A	GN 2/3 - H 6.5 CM	1032927
B	GN 2/3 - H 6.5 CM	1069058

NEW



■ STAND FOR 1065165

CODE
1065166





OUZI ROUND CHAFING DISH
STAINLESS STEEL

DIMENSION	CAP.	CODE
Ø 72.5 X H 50.5 CM	36 LTR	1054403



STACKABLE

STACKABLE ROLL TOP CHAFING DISH GN 1/1
STAINLESS STEEL

DIMENSION	CAP.	CODE
L 68.5 X W 55.5 CM X H 48 CM	9 LTR	1065387



BANQUET ROLL TOP CHAFING DISH GN 1/1
STAINLESS STEEL

DIMENSION	CAP.	CODE
L 63 X W 47 CM X H 45 CM	9 LTR	1059647



ECO CHAFING DISH GN 1/1
STAINLESS STEEL

DIMENSION	CAP.	CODE
L 60 X W 35 CM X H 32 CM	9 LTR	1059648



NEW

FUEL HOLDER CUP
STAINLESS STEEL

DIMENSION	CODE
L 9.3 X W 17 X H 6.5 CM	1022158



A

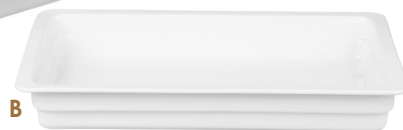

B



C



D



E



F



G



H

INSERTS FOR 1065387 / 1059647 / 1059648

	DESCRIPTION	DIMENSION	CODE
A	STAINLESS STEEL	GN 1/1 - H 6.5 CM	1065268
B	PORCELAIN	GN 1/1 - H 6.5 CM	1007705
C	PORCELAIN	GN 1/1 - H 6.5 CM	1069054
D	PORCELAIN	GN 1/1 - H 6.5 CM	1069055
E	PORCELAIN	GN 1/1 - H 6.5 CM	1064448
F	PORCELAIN	GN 1/1 - H 6.5 CM	1064492
G	PORCELAIN	GN 1/1 - H 6.5 CM	1064592
H	PORCELAIN	GN 1/1 - H 6.5 CM	1064640

NEW

NEW

NEW

NEW

NEW

NEW



SOVEREIGN ROUND CHAFING DISH

COPPER

DIMENSION	CAP.	CODE
Ø 38 X H 41 CM	6 LTR	1065188



SOUP KETTLE ELECTRIC

TEMPERATURE RANGE: 30 °C TO 95 °C

REMOVABLE STAINLESS STEEL INSERT POT

STAINLESS STEEL HINGED LID

HEAT-INSULATED HANDLE

DIMENSION	CAP.	POWER	VOLTAGE	CODE
Ø 34.5 X H 36 CM	9 LTR	0,4 KW	230V - 50HZ	89800



SERVING SPOON CLASSIC

STAINLESS STEEL

DIMENSION	CODE
L 32.5 CM	1061369



SERVING FORK CLASSIC

STAINLESS STEEL

DIMENSION	CODE
L 32 CM	1061370



SERVING LADLE CLASSIC

STAINLESS STEEL

DIMENSION	CODE
L 31 CM	1061372



CAKE SERVER CLASSIC

STAINLESS STEEL

DIMENSION	CODE
L 23 CM	1044521



SPOON HOLDER

STAINLESS STEEL

	DIMENSION	CODE
MIRROR FINISH	Ø 10.5 X H 17.8 CM	1034436
HAMMERED	Ø 10.5 X H 17.8 CM	1029150



SAUCE LADLE CLASSIC

STAINLESS STEEL

DIMENSION	CODE
L 28.5 CM	1061371



SPAGHETTI SPOON CLASSIC

STAINLESS STEEL

DIMENSION	CODE
L 32.5 CM	1054963



France



INDUCTION HOB GEOLINE BUFFET 2 ZONES

- DUAL COOKING CONCEPT
- KEEP WARM FUNCTION
- TOUCH PAD
- COMPLETELY WATERPROOF
- VITRO CERAMIC GLASS 4MM TO RESIST TO HIGH TEMPERATURE
- GLASS DIMENSION: L 53 X W 32.5 X H 0.4 CM
- POWER : 1.75KW PER HEATING ELEMENT

DIMENSION	POWER	VOLTAGE	CODE
L 53 X W 40.5 X H 7.4 CM	3.5 KW	220/240 V / 50-60 HZ	1062193



PALACE INDUCTION HEATER

TO BE USED WITH STAND 1059641 OR 1059643

DIMENSION	POWER	VOLTAGE	CODE
Ø 24 CM	900 W	220/240 V / 50-60HZ	1048882



NEW

CASSEROLE TRENDY ROUND

CAST IRON

COLOR	DIMENSION	CAPACITY	CODE
ORANGE	Ø 28 X H 14.5 CM	6.7 LTR	1072024
WHITE	Ø 28 X H 14.5 CM	6.7 LTR	1072022
BLUE	Ø 28 X H 14.5 CM	6.7 LTR	1072025
GREY	Ø 28 X H 14.5 CM	6.7 LTR	1072023



CASSEROLE TRENDY ROUND

RED, CAST IRON

DIMENSION	CAPACITY	CODE
Ø 20 X H 13 CM	2.6 LTR	1046031
Ø 24 X H 13 CM	4.5 LTR	1046033
Ø 28 X H 14.5 CM	6.7 LTR	1046035



CASSEROLE TRENDY ROUND

BLACK, CAST IRON

DIMENSION	CAPACITY	CODE
Ø 20 X H 13 CM	2.6 LTR	1046030
Ø 24 X H 13 CM	4.5 LTR	1046032
Ø 28 X H 14.5 CM	6.7 LTR	1046034



NEW

CASSEROLE TRENDY OVAL

CAST IRON

COLOR	DIMENSION	CAPACITY	CODE
ORANGE	L 29 X H 14 CM	4.8 LTR	1072028
WHITE	L 29 X H 14 CM	4.8 LTR	1072026
BLUE	L 29 X H 14 CM	4.8 LTR	1072029
GREY	L 29 X H 14 CM	4.8 LTR	1072027



NEW

CASSEROLE LOW SHAPE TRENDY ROUND

CAST IRON

COLOR	DIMENSION	CAPACITY	CODE
ORANGE	Ø 28 X H 8 CM	3.4 LTR	1048988
WHITE	Ø 28 X H 8 CM	3.4 LTR	1072020
BLUE	Ø 28 X H 8 CM	3.4 LTR	1048986
GREY	Ø 28 X H 8 CM	3.4 LTR	1072021



CASSEROLE TRENDY OVAL

RED, CAST IRON

DIMENSION	CAPACITY	CODE
L 25 X H 13.5 CM	3.3 LTR	1046037
L 29 X H 14 CM	4.8 LTR	1046039



CASSEROLE LOW SHAPE TRENDY ROUND

RED, CAST IRON

DIMENSION	CAPACITY	CODE
Ø 24 X H 8 CM	2.4 LTR	1046041
Ø 28 X H 8 CM	3.4 LTR	1046043



CASSEROLE TRENDY OVAL

BLACK, CAST IRON

DIMENSION	CAPACITY	CODE
L 25 X H 13.5 CM	3.3 LTR	1046036
L 29 X H 14 CM	4.8 LTR	1046038



CASSEROLE LOW SHAPE TRENDY ROUND

BLACK, CAST IRON

DIMENSION	CAPACITY	CODE
Ø 24 X H 8 CM	2.4 LTR	1046040
Ø 28 X H 8 CM	3.4 LTR	1046042



NEW

WOK WITH 2 HANDLES

BLACK, CAST IRON, FLAT BOTTOM

DIMENSION	CODE
Ø 38 CM	1073422



SUITABLE FOR INDUCTION



ALSO AVAILABLE IN GREEN PURPLE



**CHEF'S FUSION
COLLECTION**



ROUND CASSEROLE BLACK

PORCELAIN, WITHOUT LID

DIMENSION	CODE
Ø 28 X H 11.5 CM	1069419
Ø 16 X H 4.5 CM	1069416



LID

PORCELAIN

DIMENSION	CODE
Ø 28 CM	1069420
Ø 16 CM	1069417



**ROUND CASSEROLE
BRIGHT RED**

PORCELAIN, WITHOUT LID

DIMENSION	CODE
Ø 28 X H 11.5 CM	1069502
Ø 16 X H 4.5 CM	1069499



LID

PORCELAIN

DIMENSION	CODE
Ø 28 CM	1069503
Ø 16 CM	1069500



ROUND CASSEROLE GREY

PORCELAIN, WITHOUT LID

DIMENSION	CODE
Ø 28 X H 11.5 CM	1069461
Ø 16 X H 4.5 CM	1069458



LID

PORCELAIN

DIMENSION	CODE
Ø 28 CM	1069462
Ø 16 CM	1069459



ROUND CASSEROLE WHITE

PORCELAIN, WITHOUT LID

DIMENSION	CODE
Ø 28 X H 11.5 CM	1069544
Ø 16 X H 4.5 CM	1069541



LID

PORCELAIN

DIMENSION	CODE
Ø 28 CM	1069545
Ø 16 CM	1069542





OVAL DISH BLACK
PORCELAIN, WITHOUT LID

DIMENSION	CODE
L44.5 X W25 X H6 CM	1069449
L37.2 X W21 X H6 CM	1069446
L31 X W17.5 X H6 CM	1069443

LID
PORCELAIN

DIMENSION	CODE
L44.5 X W25 CM	1069450
L37.2 X W21 CM	1069447
L31 X W17.5 CM	1069444



OVAL DISH BRIGHT RED
PORCELAIN, WITHOUT LID

DIMENSION	CODE
L44.5 X W25 X H6 CM	1069532
L37.2 X W21 X H6 CM	1069529
L31 X W17.5 X H6 CM	1069526

LID
PORCELAIN

DIMENSION	CODE
L44.5 X W25 CM	1069533
L37.2 X W21 CM	1069530
L31 X W17.5 CM	1069527



OVAL DISH GREY
PORCELAIN, WITHOUT LID

DIMENSION	CODE
L44.5 X W25 X H6 CM	1069491
L37.2 X W21 X H6 CM	1069488
L31 X W17.5 X H6 CM	1069485

LID
PORCELAIN

DIMENSION	CODE
L44.5 X W25 CM	1069492
L37.2 X W21 CM	1069489
L31 X W17.5 CM	1069486



OVAL DISH WHITE
PORCELAIN, WITHOUT LID

DIMENSION	CODE
L44.5 X W25 X H6 CM	1069574
L37.2 X W21 X H6 CM	1069571
L31 X W17.5 X H6 CM	1069568

LID
PORCELAIN

DIMENSION	CODE
L44.5 X W25 CM	1069575
L37.2 X W21 CM	1069572
L31 X W17.5 CM	1069569



RECTANGULAR DISH BLACK
PORCELAIN, WITHOUT LID

DIMENSION	CODE
L39 X W24 X H6 CM	1069440
L32 X W22 X H6 CM	1069437
L20 X W10 X H6 CM	1069434

LID
PORCELAIN

DIMENSION	CODE
L39 X W24 CM	1069441
L32 X W22 CM	1069438
L20 X W10 CM	1069435



RECTANGULAR DISH BRIGHT RED
PORCELAIN, WITHOUT LID

DIMENSION	CODE
L39 X W24 X H6 CM	1069523
L32 X W22 X H6 CM	1069520
L20 X W10 X H6 CM	1069517

LID
PORCELAIN

DIMENSION	CODE
L39 X W24 CM	1069524
L32 X W22 CM	1069521
L20 X W10 CM	1069518



RECTANGULAR DISH GREY
PORCELAIN, WITHOUT LID

DIMENSION	CODE
L39 X W24 X H6 CM	1069482
L32 X W22 X H6 CM	1069479
L20 X W10 X H6 CM	1069476

LID
PORCELAIN

DIMENSION	CODE
L39 X W24 CM	1069483
L32 X W22 CM	1069480
L20 X W10 CM	1069477



RECTANGULAR DISH WHITE
PORCELAIN, WITHOUT LID

DIMENSION	CODE
L39 X W24 X H6 CM	1069565
L32 X W22 X H6 CM	1069562
L20 X W10 X H6 CM	1069559

LID
PORCELAIN

DIMENSION	CODE
L39 X W24 CM	1069566
L32 X W22 CM	1069563
L20 X W10 CM	1069560





TABLE NUMBER EASELBOARD

PACK OF 5 + 1 CHALK MARKER

DIMENSION	CODE
W 7 X H 15 CM	1073061



LABEL HOLDER

WOOD
PACK OF 4 + 20 WHITE LABELS

DIMENSION	CODE
L 2.5 X W 2.5 X H 12 CM	1052564



NEW



HALF MOON LABEL HOLDER

STAINLESS STEEL

DIMENSION	CODE
L 5 X W 5 X H 2.5 CM	1072418



NEW

STONE LABEL HOLDER

DIMENSION	COLOR	CODE
L 3.18 X W 2.54 X H 1.27 CM	BLACK	1075168
L 3.18 X W 2.54 X H 1.27 CM	GREY	1075169



NEW



LABEL HOLDER

PLEXI GLASS
PACK OF 4 + 20 WHITE LABELS

DIMENSION	CODE
L 3 X W 3 X H 12 CM	1045528



MENU LABEL HOLDER

NICKEL PLATED

		DIMENSION	CODE
A	CUBE	L 2.5 X W 2.5 X H 2.5 CM	1026503
B	ELLIPSE	Ø 3 X H 4.5 CM	1026505
C	CYLINDER	L 3.8 X W 2.5 X H 2.2 CM	1026506



FLEXIBLE LABEL HOLDER WITH 2 CLIPS

DIMENSION	CODE
L 12 CM	1051088

WHITE LABEL

DIMENSION	CODE
L 7.5 X W 5.2 CM	1051089



BUFFET CARD STAND

STAINLESS STEEL

DIMENSION	CODE
L 10.5 X W 5.8 X H 16 CM	1032880



LABEL HOLDER & LABEL

DIMENSION	CODE
PACK OF 6 HOLDERS CHROME L 4 X W 2.5 CM	1040383
12 BLACK LABELS L 10 X W 5.7 CM	



MENU LABEL HOLDER

PORCELAIN

DIMENSION	CODE
L 10.5 X W 7.5 CM	1007286



TABLE NUMBER

STAINLESS STEEL, PACK OF 12

NUMBERS	DIMENSION	CODE
1 TO 12	L 5.3 X W 4.5 X H 3.5 CM	1038918
13 TO 24	L 5.3 X W 4.5 X H 3.5 CM	1039202
25 TO 36	L 5.3 X W 4.5 X H 3.5 CM	1039203
37 TO 48	L 5.3 X W 4.5 X H 3.5 CM	1039204
49 TO 60	L 5.3 X W 4.5 X H 3.5 CM	1052386
61 TO 72	L 5.3 X W 4.5 X H 3.5 CM	1052387



RESERVED SIGN

STAINLESS STEEL, PACK OF 2

DIMENSION	CODE
L 5.5 X W 5 X H 3.5 CM	1045894



NON-SMOKING SIGN

STAINLESS STEEL, PACK OF 2

DIMENSION	CODE
L 5.5 X W 5 X H 3.5 CM	1065822



**TABLE SIGN
NATURAL SLATE**

DIMENSION	CODE
L 7 X W 5 X H 3 CM	1059941



TABLE NUMBER STAND

STAINLESS STEEL

DIMENSION	CODE
H 30 CM	1060597





NEW

BREAD KNIFE LAGUIOLE EXPRESSION

DIMENSION	CODE
L 20 CM	1068024



BREAD KNIFE COCOON

STAINLESS STEEL

DIMENSION	CODE
L 20,5 CM	1031757



BREAD BOARD GN 1/1 WITHOUT TRAY

WOOD

DIMENSION	CODE
L 53 X W 32,5 CM	1051086

TRAY GN 1/1 FOR BREAD BOARD

STAINLESS STEEL

DIMENSION	CODE
L 53 X W 32,5 X H 2 CM	1065266



NEW

END GRAIN BUTCHER BLOCK

TEAK

DIMENSION	CODE
Ø 45 X H 5 CM	1073005



BREAD BOARD WITH TRAY

WOOD

DIMENSION	CODE
L 47,5 X W 32 CM	1051087





NEW

EGG BASKET

RATTAN

DIMENSION	CODE
Ø 26 X H 17 CM	1063433



NEW

BASKET RECTANGULAR

WILLOW NATURAL WOOD

DIMENSION	CODE
L 35 X W 25,4 X H 7,6 CM	1072393
L 45,7 X W 33 X H 7,6 CM	1072394



NEW

BASKET ANGLED

WILLOW NATURAL WOOD

DIMENSION	CODE
L 48,3 X W 39,4 X H 19/5 CM	1072395



BREAD BAGUETTES BASKET

WICKER

DIMENSION	CODE
L 30 X W 28 X H 51 CM	1009050



ROUND PLATTER WITH 2 HANDLES

WICKER

NEW

DIMENSION	CODE
Ø 35 CM	10794



BASKET WITH 2 HANDLES

WICKER

DIMENSION	CODE
L 50 X W 45 CM	633932



BASKET

WICKER

DIMENSION	CODE
L 61 X W 45 X H 13 CM	1061920



GN SYSTEM

BEIGE, POLYPROPYLENE
WICKERWORK, VERY SOLID, WITH STAINLESS
STEEL WIRE FRAME TO STABILIZE THE BASKET

SIZE	DIMENSION	CODE
GN 1/1	L 53 X W 32,5 X H 6,5 CM	1050295
GN 1/2	L 32,5 X W 26,5 X H 6,5 CM	1050296
GN 1/3	L 32,5 X W 17,6 X H 6,5 CM	1050297

SIZE	DIMENSION	CODE
GN 1/1	L 53 X W 32,5 X H 10 CM	1044525
GN 1/2	L 32,5 X W 26,5 X H 10 CM	1044526
GN 1/3	L 32,5 X W 17,6 X H 10 CM	1061947



GN SYSTEM

BLACK, POLYPROPYLENE

SIZE	DIMENSION	CODE
GN 1/1	L 53 X W 32,5 X H 6,5 CM	1051292
GN 1/2	L 32,5 X W 26,5 X H 6,5 CM	1051294
GN 1/3	L 32,5 X W 17,6 X H 6,5 CM	1061948

SIZE	DIMENSION	CODE
GN 1/1	L 53 X W 32,5 X H 10 CM	1052128
GN 1/2	L 32,5 X W 26,5 X H 10 CM	1052129
GN 1/3	L 32,5 X W 17,6 X H 10 CM	1052213



ROUND BASKET

BEIGE, POLYPROPYLENE

DIMENSION	CODE
Ø 20 X H 8 CM	1053085





END GRAIN BUTCHER BLOCK

TEAK

DIMENSION	CODE
Ø 45 X H 5 CM	1073005



NEW

END GRAIN CHEESE BOARD

TEAK

DIMENSION	CODE
L46 X W15 X H 5 CM	1073008



PROTEAK CUTTING BOARD OIL

NEW

CAP.	CODE
35.5 CL	1073017



NEW

ESSENTIAL GIANT BOARD

TEAK

DIMENSION	CODE
Ø 71 X H 1.4 CM	1073189



COVERED CHEESE TRAY WITH WOODEN BOARD

DIMENSION	CODE
Ø 45 X H 24 CM	1057199



REVOLVING CHEESE TRAY

WOOD

DIMENSION	CODE
Ø 35 CM	1061919



NEW

CHEESE KNIFE

WOODEN HANDLE

DIMENSION	CODE
L 17 CM	1011431



NEW

CHEESE KNIFE

OLIVE WOOD HANDLE

DIMENSION	CODE
L 11 CM	1067916



CHEESE KNIFE COCOON

STAINLESS STEEL

DIMENSION	CODE
L 20.5 CM	1031758



NEW

END GRAIN CARVING BOARD

WITH HAND GRIP, TEAK

DIMENSION	CODE
30.5 X 30.5 X H 5 CM	1073007



NEW

END GRAIN CARVING BOARD

WITH HAND GRIP, TEAK

DIMENSION	CODE
61 X 46 X H 3.8 CM	1073006

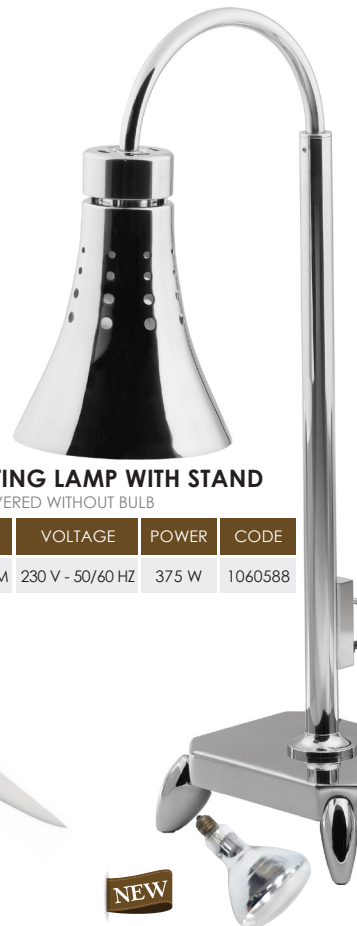

DOMINO HEATING LAMP WITH STAND

STAINLESS STEEL, DELIVERED WITHOUT BULB

DIMENSION	VOLTAGE	POWER	CODE
L 20.4 X W 37.5 X H 72.5 CM	230 V - 50/60 HZ	375 W	1060588



CHEF FORK

FORGED STAINLESS STEEL

DIMENSION	CODE
L 32 CM	1042577



ABSOLU SLICING KNIFE

	DIMENSION	CODE
A BLACK ABS HANDLE	L 22 CM	1049444
B ROSEWOOD HANDLE	L 22 CM	1059246



EXPRESSION SLICING KNIFE

ABS HANDLE

DIMENSION	CODE
L 22 CM	1059247

NEW

INFRARED BULB FOR 1060588

POWER	CODE
250 W	1070724



SAUCE LADLE

STAINLESS STEEL

	DIMENSION	CODE
A	L 18.5 CM	1008693
B	L 17 CM	1013411
C	L 17.3 CM	1021391



DRESSING POT WITH LID

WHITE PORCELAIN
STAINLESS STEEL LID

DIMENSION	CAP.	CODE
Ø 13 X H 13 CM	0.8 LTR	1051085



HAMMERED SAUCE BOWL WITH LADLE

STAINLESS STEEL

DIMENSION	CODE
L 16.5 X W 13.1 X H 8.5 CM	1029164



NEW



ICE TRAY WITH DRAIN

STAINLESS STEEL, GLASS

DIMENSION	CODE
L 90 X W 45 X H 19 CM	1071523
L 60 X W 45 X H 19 CM	1071524
L 45 X W 45 X H 19 CM	1071525



CHOCOLATE FOUNTAIN
STAINLESS STEEL

DIMENSION	CAP.	POWER	VOLTAGE	CODE
Ø 33 X H 48 CM	2,5 KG	340W	230V - 50 HZ	1075262



COMMERCIAL CHOCOLATE FOUNTAIN
STAINLESS STEEL

NEW

DIMENSION	CAP.	POWER	VOLTAGE	CODE
Ø 33 X H 58 CM	2 TO 4.5 KG	150W	220V - 50/60 HZ	1075106
Ø 40 X H 101 CM	5 TO 8 KG	100W	220V - 50/60 HZ	1075107





CASCADING CHOCOLATE FOUNTAIN

STAINLESS STEEL



DIMENSION	CAP.	POWER	VOLTAGE	CODE
Ø 40 X H 86 CM	2 TO 4.5 KG	450W	220V - 50/60 HZ	1075109



CASCADING DUAL CHOCOLATE FOUNTAIN

STAINLESS STEEL



DIMENSION	CAP.	POWER	VOLTAGE	CODE
Ø 52 X H 91 CM	2.3 TO 6.8 KG	550W	220V - 50/60 HZ	1075110
Ø 52 X H 139 CM	3.6 TO 6.8 KG	500W	220V - 50/60 HZ	1075111



COMMERCIAL TRIPLE CHOCOLATE FOUNTAIN

STAINLESS STEEL



DIMENSION	CAP.	POWER	VOLTAGE	CODE
Ø 52 X H 116 CM	4.5 TO 9 KG	600W	220V - 50/60 HZ	1075112





NEW

SLOTTED SPOON
OLIVE WOOD

DIMENSION	CODE
L 20 CM	1067918



NEW

SERVICE SPOON
OLIVE WOOD

DIMENSION	CODE
L 30 CM	1067912



NEW

PICKLES TONG
OLIVE WOOD

DIMENSION	CODE
L 18 CM	1067913



CAKE TONG
STAINLESS STEEL

	DIMENSION	CODE
SLOTTED	L 20 CM	1056367
PLAIN	L 18 CM	816850



TONG
STAINLESS STEEL

	DIMENSION	CODE
SPAGHETTI TONG	L 19 CM	11138
PASTA ROUND TONG	L 24 CM	1060492

BREAD TONG
STAINLESS STEEL

	DIMENSION	CODE
MIRROR FINISH	L 23 CM	1011196
HAMMERED	L 23.5 CM	1029160



SCISSORS TYPE TONG
STAINLESS STEEL

DIMENSION	CODE
L 25 CM	1060490



SERVING TONG LUXE
STAINLESS STEEL

DIMENSION	CODE
L 30 CM	1008694



SERVING TONG
STAINLESS STEEL

	DIMENSION	CODE
SPOOK	L 21 CM	1036837
MULTIPURPOSE	L 24 CM	1005451



SERVING TONG SHELL SHAPED
STAINLESS STEEL

DIMENSION	CODE
L 30 CM	89854



HAMBURGER TONG
STAINLESS STEEL

DIMENSION	CODE
L 24 CM	1060493





SPOON HOLDER
STAINLESS STEEL

	DIMENSION	CODE
MIRROR FINISH	Ø 10.5 X H 17.8 CM	1034436
HAMMERED	Ø 10.5 X H 17.8 CM	1029150



SERVING FORK CLASSIC
STAINLESS STEEL

DIMENSION	CODE
L 32 CM	1061370



CAKE SERVER CLASSIC
STAINLESS STEEL

DIMENSION	CODE
L 23 CM	1044521



SPAGHETTI SPOON CLASSIC
STAINLESS STEEL

DIMENSION	CODE
L 32.5 CM	1054963



SAUCE LADLE CLASSIC
STAINLESS STEEL

DIMENSION	CODE
L 28.5 CM	1061371



SERVING SPOON CLASSIC
STAINLESS STEEL

DIMENSION	CODE
L 32.5 CM	1061369



SERVING LADLE CLASSIC
STAINLESS STEEL

DIMENSION	CODE
L 31 CM	1061372



PLAIN SERVING SPOON
POLYCARBONATE

COLOR	DIMENSION	CODE
CLEAR	L 33 CM	1029250
BLACK	L 28 CM	1020227



PERFORATED SERVING SPOON
POLYCARBONATE

COLOR	DIMENSION	CODE
CLEAR	L 33 CM	1019593
BLACK	L 28 CM	1030614



PLAIN SERVING SPOON
POLYCARBONATE

COLOR	DIMENSION	CODE
CLEAR	L 20.5 CM	1031811
BLACK	L 20.5 CM	1031812



SCALLOP GRIP SERVING TONG
POLYCARBONATE

COLOR	DIMENSION	CODE
CLEAR	L 23 CM	43310
BLACK	L 23 CM	43311
CLEAR	L 30.5 CM	43312
BLACK	L 30.5 CM	43313



ANGLED SERVING TONG
POLYCARBONATE

COLOR	DIMENSION	CODE
BLACK	L 21 CM	1013658
BLACK	L 27.5 CM	1020228



FLAT GRIP SERVING TONG
POLYCARBONATE

COLOR	DIMENSION	CODE
CLEAR	L 15 CM	1031813
BLACK	L 15 CM	1031814



EASY GRASP SERVING TONG
POLYCARBONATE

COLOR	DIMENSION	CODE
BLACK	L 24 CM	1035624



SERVING LADLE
POLYCARBONATE

COLOR	DIMENSION	CODE
CLEAR	L 21.6 CM	43306
BLACK	L 21.6 CM	43307
BLACK	L 26.8 CM	43309



ODIN JUICE DISPENSER

DIMENSION	CAP.	CODE
L 32.5 X W 20 X H 46 CM	4 LTR	1016966
L 32.5 X W 20 X H 56 CM	7 LTR	1014320



ODIN CEREAL DISPENSER SINGLE

DIMENSION	CAP.	CODE
L 26.5 X W 20 X H 59.5 CM	3.7 LTR	1014682



ODIN CEREAL DISPENSER DOUBLE

DIMENSION	CAP.	CODE
L 26.5 X W 31 X H 59.5 CM	2 X 3.7 LTR	1014321



ODIN COFFEE URN

DIMENSION	CAP.	CODE
L 31.5 X W 31.5 X H 41.5 CM	12 LTR	1014292
L 31.5 X W 31.5 X H 57.5 CM	19 LTR	1035301



ODIN MILK DISPENSER

DIMENSION	CAP.	CODE
L 32.5 X W 20 X H 43 CM	5 LTR	1014364



HI-LINE JUICE DISPENSER

DIMENSION	CAP.	CODE
L 43 X W 23 X H 56 CM	7 LTR	1025324



HI-LINE MILK DISPENSER

DIMENSION	CAP.	CODE
L 37.5 X W 23.5 X H 48 CM	5 LTR	1061946



HI-LINE CEREAL DISPENSER

DIMENSION	CAP.	CODE
L 22 X W 21 X H 61 CM	3.7 LTR	1025323



BEVERAGE DISPENSER
BEEHIVE, GLASS

CAP.	CODE
9.5 L	1070589



BEVERAGE DISPENSER
MASON, GLASS

CAP.	CODE
7.5 CL	1072402



BEVERAGE DISPENSER
RUSTIC COUNTRY, GLASS

CAP.	CODE
9.5 L	1070588



GALVANIZED TUB/BASE
FOR 1070589/1070588

DIMENSION	CODE
Ø 23.8 X H 19 CM	1070590



CHALKBOARD NECKLACE
FOR BEVERAGE DISPENSER

CODE
1072403

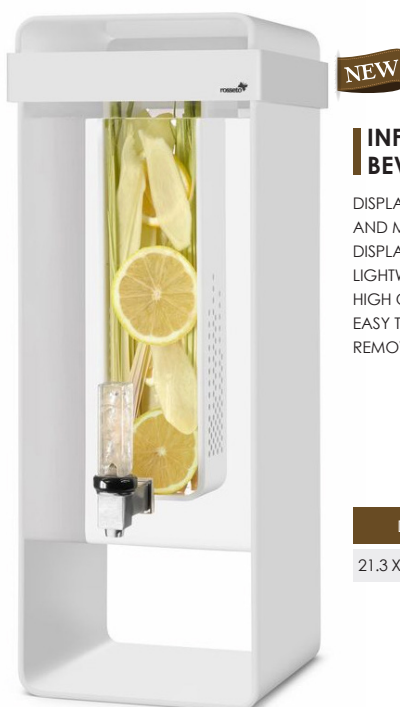

INFUSION WHITE
BEVERAGE DISPENSER

DISPLAY HERBAL ICED TEAS, FLAVORED VODKAS,
AND MORE IN A SLEEK, MODERN WAY
DISPLAY FRUIT WITHOUT CONTAMINATING WATER
LIGHTWEIGHT
HIGH QUALITY MATERIALS
EASY TO CLEAN
REMOVABLE CENTRAL INFUSION CHAMBER

DIMENSION	CAPACITY	CODE
21.3 X 21.3 X H 55.9 CM	11.4 LTR	1071976



SAMOVAR 3006C

STAINLESS STEEL

DIMENSION	CAP.	CODE
L 34.5 X W 38 X H 53.7 CM	6 LTR	1065999



SAMOVAR ROYAL III

STAINLESS STEEL

DIMENSION	CAP.	CODE
L 49.5 X W 41.5 X H 74 CM	6 LTR	1066000



UNBREAKABLE

OXYGENE INSULATED JUG

STAINLESS STEEL 18/10 MIRROR FINISH
DOUBLE WALL WITH AIR SPACE

CAP.	CODE
30 CL	1053512
60 CL	1053513
100 CL	1052855



UNBREAKABLE

ALYZEE INSULATED JUG

STAINLESS STEEL 18/10 SATIN FINISH
DOUBLE WALL WITH AIR SPACE

CAP.	CODE
200 CL	1053519



UNBREAKABLE

PAUSE CAFE INSULATED JUG

STAINLESS STEEL
DOUBLE WALL WITH AIR SPACE

COLOR	CAP.	CODE
BLACK	60 CL	1049696
	130 CL	1049698
RED	60 CL	1049697
	130 CL	1049699



A B C

UNBREAKABLE

INSULATED JUG

STAINLESS STEEL, DOUBLE WALL

	CAP.	CODE
A	100 CL	812819
B	200 CL	812818
C	SPARE LID FOR 812819 / 812818	1049690



UNBREAKABLE

INSULATED JUG WITH PUMP

STAINLESS STEEL, DOUBLE WALL

CAP.	CODE
250 CL	1003166



ADHESIVE LABELS

INCLUDES :
4 X COFFEE
3 X MILK
3 X WARM WATER

CODE
812912



KAMINA COFFEE POT
STAINLESS STEEL

CAP.	CODE
50 CL	1029185
100 CL	1061747



KAMINA TEA POT
STAINLESS STEEL

CAP.	CODE
25 CL	1061748
50 CL	1029184
100 CL	1061749



KAMINA CREAMER
STAINLESS STEEL

CAP.	CODE
15 CL	1038566
25 CL	1029183
60 CL	1038567



KAMINA SUGAR BOWL
STAINLESS STEEL

CAP.	CODE
25 CL	1029182



EMINENCE GOOSE NECK COFFEE POT
STAINLESS STEEL

CAP.	CODE
35 CL	1061750
60 CL	1029192
100 CL	1061751



EMINENCE GOOSE NECK TEA POT
STAINLESS STEEL

CAP.	CODE
35 CL	1061752
60 CL	1029191
100 CL	1061753



EMINENCE CREAMER
STAINLESS STEEL

CAP.	CODE
15 CL	1061754
25 CL	1029188



EMINENCE SUGAR BOWL WITH LID
STAINLESS STEEL

CAP.	CODE
25 CL	1061755



NEW

TEA POT

CAST IRON, BLACK, FILTER INCLUDED

CAP.	CODE
30 CL	1056733
60 CL	1016241



TEA POT

CAST IRON, RED JASMINE
FILTER INCLUDED

CAP.	CODE
80 CL	1034491



TEA PRESS ASSAM

WITH STAINLESS STEEL FILTER

CAP.	CODE
50 CL	1024966



**COFFEE PRESS
CHAMBORD**

CAP.	CODE
35 CL	185015
50 CL	185016
100 CL	185017



**SPARE GLASS
FOR COFFEE PRESS
CHAMBORD**

CAP.	CODE
35 CL	185005
50 CL	185011
100 CL	185007



JAM HONEY STAND

STAINLESS STEEL



DIMENSION	CODE
L 18 X W 5 X H 1 CM	1032868



**JAM HONEY STAND
5 COMPARTMENTS
WITH VASE**

STAINLESS STEEL

DIMENSION	CODE
H 18 CM	1032869



NEW

JAM SPOON

OLIVE WOOD

DIMENSION	CODE
L 25 CM	1067917





ROMA HONEY & CREAM DISPENSER

GLASS, STAINLESS STEEL

CAP.	CODE
25 CL	1052413



HONEY POT
WITH WOODEN DIPPER

CAP.	CODE
40 CL	1069842

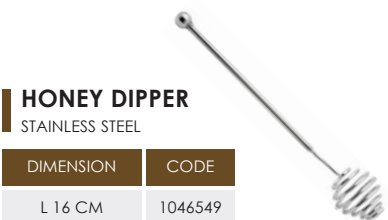

HONEY DIPPER
STAINLESS STEEL

DIMENSION	CODE
L 16 CM	1046549

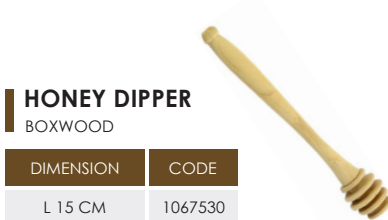

HONEY DIPPER
BOXWOOD

DIMENSION	CODE
L 15 CM	1067530

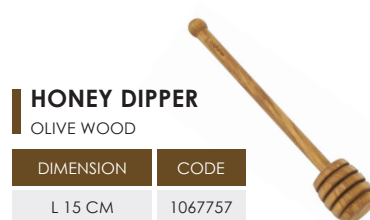

HONEY DIPPER
OLIVE WOOD

DIMENSION	CODE
L 15 CM	1067757



SUGAR PACK HOLDER
PLASTIC

COLOR	DIMENSION	CODE
CLEAR	L 8.25 X W 6.35 X H 5.1 CM	1072982
WHITE	L 8.25 X W 6.35 X H 5.1 CM	1072983



SUGAR PACK HOLDER
FLUTED GLASS

DIMENSION	CODE
L 8.25 X W 6.35 X H 5.1 CM	1072984



SUGAR PACK HOLDER
GALVANIZED STEEL

DIMENSION	CODE
L 12.7 X W 7.6 X H 6.4 CM	1072951



SUGAR PACK HOLDER
STAINLESS STEEL

DIMENSION	CODE
L 6.7 X W 6.7 X H 6.7 CM	1032872



ROMA SUGAR DISPENSER
GLASS, STAINLESS STEEL

CAP.	CODE
25 CL	1052414



SUGAR TONG
STAINLESS STEEL

DIMENSION	CODE
L 11 CM	1031693



TEA BOX
BEECHWOOD

DIMENSION	CODE
L 33.5 X W 20 X H 9 CM	1048577



NEW

BIRD CAGE STAND

BROWN STEEL, WITHOUT PLATE

DIMENSION	CODE
Ø 32 X H 40 CM	1071597
Ø 40 X H 65 CM	1071598

**LED UNDER LIGHTING
3-TIER FROSTED GLASS DISPLAY**

DIMENSION	CODE
45 X H 70 CM	1071606



NEW



NEW

**MERIDIAN STAND WITH
4 TEXTURED BROWN
GLASS TRAYS**

DIMENSION	CODE
80 X 30 X H 70 CM	1071603

**SPARE 4 TEXTURED BROWN
GLASS TRAYS FOR 1071603**

DIMENSION	CODE
31X22 CM - 76 X 22 CM	1071604
36 X 22 CM - 60 X 22 CM	



NEW

**PYRAMID STAND WITH
TEXTURED BROWN GLASS TRAYS**

	DIMENSION	CODE
WITH 3 TRAYS	32 X 14 X H 45 CM	1071599
WITH 4 TRAYS	60 X 20 X H 80 CM	1071601

**SPARE TEXTURED BROWN GLASS
TRAYS FOR 1071599/1071601**

	DIMENSION	CODE
3 TRAYS	70X10 - 60X10 - 50X10 CM	1071600
4 TRAYS	105 X 15 CM - 90 X 15 CM 75 X 15 CM - 60 X 15 CM	1071602





RECTANGULAR DISPLAY WITH 2 DRAWERS + LID

DIMENSION	CODE
26.5 X 13.2 X H 12.5 CM	1073212



SQUARE DISPLAY WITH 2 DRAWERS + LID

DIMENSION	CODE
26.5 X 26.5 X H 12.5 CM	1073213



AFTERNOON TEA STAND

STAINLESS STEEL, WITHOUT PLATE

DIMENSION	CODE
L 33.5 X W 21 X H 51.5 CM	1029136

PLATES FOR 1029136

GLASS, PACK OF 3

DIMENSION	CODE
L 16 X W 12 (TOP)	1029137
L 20 X W 14.8 (MIDDLE)	
L 29.8 X W 19 CM (BOTTOM)	



HIGH TEA RACK

WOOD
STAINLESS STEEL HANDLE

DIMENSION	CODE
L 34 X W 10 X H 38 CM	1061759



AFTERNOON TEA STAND

STAINLESS STEEL, ACRYLIC

INCLUDES : 3 BLACK PLATES

L 28.5 X W 11CM (TOP)

L 39.5 X W 11CM (MIDDLE)

L 28.5 X W 11CM (BOTTOM)

DIMENSION	CODE
L 33.5 X W 13.3 X H 40 CM	1029138

SPARE ACRYLIC PLATE SET FOR 1029138

CODE
1055356





NEW

NUTS BOWL
2 COMPARTMENTS
STAINLESS STEEL MIRROR FINISH



DIMENSION	CODE
L21.7X10XH13 CM	1073650



NEW

NUTS BOWL
2 COMPARTMENTS
STAINLESS STEEL MIRROR FINISH



DIMENSION	CODE
L21.8XW10.1XH18 CM	1073651



NEW

PETIT FOUR STAND
CHROME STEEL
2 TIERS Ø 14 / 11 CM



DIMENSION	CODE
H 16 CM	1050194

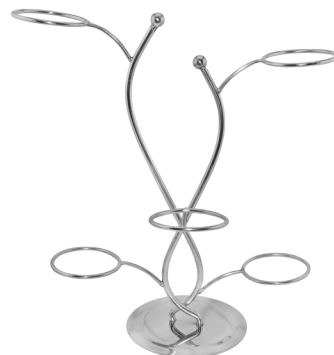

TREE BOWLS STAND
STAINLESS STEEL

DIMENSION	CODE
L 36.5 X W 21.5 X H 36.5 CM	1029134



SERVING STAND FOR 3 PLATES
STAINLESS STEEL
DELIVERED WITHOUT PLATES

10.5 cm PLATE DIMENSION MAX. Ø 17 CM
CIRCLE INSIDE Ø 10.5 CM

DIMENSION	CODE
L 18.5 X W 16 X H 26 CM	1050268

20 cm PLATE DIMENSION MAX. Ø 27.5 CM
CIRCLE INSIDE Ø 20 CM

DIMENSION	CODE
L 29 X W 20 X H 44 CM	1042648



GLASS TUMBLER
25 CL FOR 1029134

DIMENSION	CODE
H 8.8 X Ø 9 CM	985026



PORCELAIN BOWL
18 CL FOR 1029134

DIMENSION	CODE
Ø 12.7 X H 4 CM	1062108



BURJ BOWLS STAND
STAINLESS STEEL

DIMENSION	CODE
L 37 X W 27 X H 48.5 CM	1029140



GLASS BOWL 41 CL
FOR 1029140

DIMENSION	CODE
Ø 12 X H 6.7 CM	1009977



PORCELAIN BOWL
27 CL FOR 1029140

DIMENSION	CODE
Ø 12 X H 6 CM	1023836



STACKABLE TRAY
STAINLESS STEEL

DIMENSION	CODE
L 53 X W 32.5 CM	1051091



HOLDING TRAY 45 HOLES FOR 1051091

DIMENSION	CODE
Ø 3.7 CM	1051092

ALLOWS TO DISPLAY GLASSES CODES 2020, 1015276, 50006, 197072, 40122



COVER FOR 1051091
MS PLASTIC

DIMENSION	CODE
L 53 X W 32.5 X H 9 CM	1061774



RECTANGULAR TRAY WITH RIM
STAINLESS STEEL

DIMENSION	CODE	NEW
L 35 X W 27 CM	1011477	
L 40 X W 32 CM	192045	
L 45 X W 35 CM	1003636	



NEW

WOOD TRAY
WALNUT OILED

	DIMENSION	CODE
GN 1/1	L 53 X W 32.5 X H 2 CM	1065009
GN 1/2	L 26.5 X W 32.5 X H 2 CM	1065010
GN 2/4	L 53 X W 16.2 X H 2 CM	1064727



OVAL PLATTER
STAINLESS STEEL

DIMENSION	CODE
L 23 X W 14 CM	39023
L 28 X W 17.5 CM	39024
L 34 X W 22 CM	39025
L 38 X W 25 CM	39026
L 41 X W 27 CM	39027
L 46 X W 30 CM	39028
L 60 X W 27 CM	39029
L 80 X W 30 CM	39030



SQUARE PLATE WITH RIM

GLASS



	DIMENSION	CODE
CLEAR	L 20.5 X W 20.5 X H 2 CM	1030239
CLEAR	L 27.5 X W 27.5 X H 2 CM	1030235



AMBER	L 20.5 X W 20.5 X H 2 CM	1030241
AMBER	L 27.5 X W 27.5 X H 2 CM	1030236



GREY	L 20.5 X W 20.5 X H 2 CM	1030240
GREY	L 27.5 W 27.5 X H 2 CM	1030237



RED	L 20.5 X W 20.5 X H 2 CM	1030242
RED	L 27.5 X W 27.5 X H 2 CM	1030238

RECTANGULAR PLATE WITH RIM

GLASS



	DIMENSION	CODE
CLEAR	L 26.5 X W 16.3 X H 2 CM	1032799
CLEAR	L 35 X W 15 X H 1.5 CM	1032683
CLEAR	L 53 X W 32.5 X H 2 CM	1032682



AMBER	L 26.5 X W 16.3 X H 2 CM	1037763
AMBER	L 35 X W 15 X H 1.5 CM	1037777



RED	L 26.5 X W 16.3 X H 2 CM	1037764
RED	L 35 X W 15 X H 1.5 CM	1037778



GREEN	L 35 X W 15 X H 1.5 CM	1037776
-------	------------------------	---------

ROUND PLATE WITH RIM

GLASS



	DIMENSION	CODE
CLEAR	Ø 27 X H 2 CM	1032762
CLEAR	Ø 34 X H 1.5 CM	1032092
GREEN	Ø 34 X H 1.5 CM	1037765

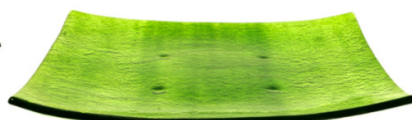

SQUARE PLATE

NEW

GLASS

	DIMENSION	CODE
GREEN	L 26.5 X W 26.5 X H 2 CM	1037779



4 COMPARTMENTS PLATE

GLASS

	DIMENSION	CODE
CLEAR	L 24 X W 24 X H 2 CM	1030267



SQUARE COUPE PLATE

GLASS

	DIMENSION	CODE
CLEAR	L 29.5 X W 29.5 X H 3 CM	1032681
AMBER	L 29.5 X W 29.5 X H 3 CM	1037768
GREEN	L 29.5 X W 29.5 X H 3 CM	1032751

SQUARE SALAD BOWL

GLASS

	DIMENSION	CODE
CLEAR	L 26 X W 26 X H 6 CM	1030271
GREY	L 26 X W 26 X H 6 CM	1030272
AMBER	L 26 X W 26 X H 6 CM	1030273
RED	L 26 X W 26 X H 6 CM	1030274
GREEN	L 26 X W 26 X H 6 CM	1037759
BLUE	L 26 X W 26 X H 6 CM	1036035
YELLOW	L 26 X W 26 X H 6 CM	1049932

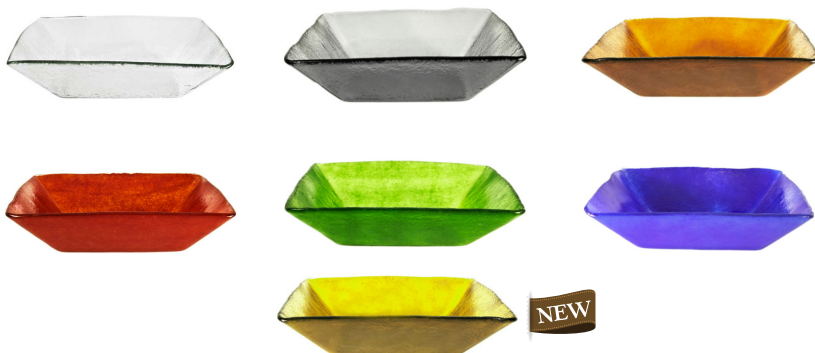

SQUARE BOWL

GLASS

	DIMENSION	CODE
CLEAR	L 14.5 X W 14.5 X H 5 CM	1032798
GREEN	L 14.5 X W 14.5 X H 5 CM	1037751
AMBER	L 14.5 X W 14.5 X H 5 CM	1037752



COUPE BOWL

GLASS

	DIMENSION	CODE
CLEAR	Ø 33 X H 5.5 CM	1032684
GREY	Ø 33 X H 5.5 CM	1032117
AMBER	Ø 33 X H 5.5 CM	1037757
RED	Ø 33 X H 5.5 CM	1037758
GREEN	Ø 33 X H 5.5 CM	1037756



COUPE BOWL

GLASS

	DIMENSION	CODE
CLEAR	Ø 27 X H 3 CM	1033334
GREEN	Ø 27 X H 3 CM	1037773
GREY	Ø 27 X H 3 CM	1046308

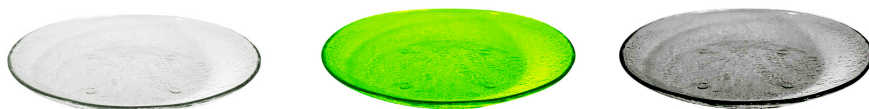

ROUND SALAD BOWL

GLASS

	DIMENSION	CODE
CLEAR	Ø 15 X H 5 CM	1033338
CLEAR	Ø 21 X H 7 CM	1030247
CLEAR	Ø 25.5 X H 8 CM	1030251
GREY	Ø 15 X H 5 CM	1032116
GREY	Ø 21 X H 7 CM	1030248
GREY	Ø 25.5 X H 8 CM	1030252
AMBER	Ø 15 X H 5 CM	1037749
AMBER	Ø 21 X H 7 CM	1030249
AMBER	Ø 25.5 X H 8 CM	1030253
RED	Ø 15 X H 5 CM	1037750
RED	Ø 21 X H 7 CM	1030250
RED	Ø 25.5 X H 8 CM	1030254
GREEN	Ø 15 X H 5 CM	1037748
GREEN	Ø 21 X H 7 CM	1037755
GREEN	Ø 25.5 X H 8 CM	1037754



2 COMPARTMENTS BOWL

GLASS

	DIMENSION	CODE
CLEAR	L 19.5 X W 10 X H 3.5 CM	1036972
GREY	L 19.5 X W 10 X H 3.5 CM	1046312
AMBER	L 19.5 X W 10 X H 3.5 CM	1037784
GREEN	L 19.5 X W 10 X H 3.5 CM	1037783



NEW

COCOON
TEMPERED GLASS



DIMENSION	CAPACITY	CODE
Ø 24 X H 13.2 CM	3.8 L	1009980
Ø 28 X H 15.3 CM	5.5 L	1009981



OSEO
CLEAR GLASS



DIMENSION	CAP.	CODE
L 17.6 X W 17.6 X H 11 CM	1.3 L	1062056
L 23.5 X W 23.5 X H 12 CM	2.5 L	1062055



TORCELLO
CLEAR GLASS

DIMENSION	CODE
L 14 X W 14 CM	53040
L 20 X W 20 CM	1029623
L 26 X W 26 CM	1029624



RUSTIC BOWL*
OLIVE WOOD

DIMENSION	CODE
L 23 - 25 X W 15 - 17 CM	1067358
L 27 - 29 X W 17 - 19 CM	1075539

NEW



SALAD BOWL*
OLIVE WOOD

DIMENSION	CODE
Ø 24 - 25 CM	1019464
Ø 30 - 31 CM	1002693



BOWL*
OLIVE WOOD

DIMENSION	CODE
Ø 10 - 11 CM	1067359
Ø 15 - 16 CM	1067360



* DUE TO THE NATURAL VARIATIONS IN OLIVE WOOD, BOWL SIZES MAY VARY



DOUBLE WALL
STAINLESS STEEL

DIMENSION	CAP.	CODE
Ø 15 X H 9.5 CM	0.6 LTR	1056390
Ø 19.5 X H 11.5 CM	1 LTR	1056389
Ø 24.5 X H 14 CM	2.4 LTR	1056387
Ø 30 X H 15 CM	3.5 LTR	1056388





RECTANGULAR TRAY

HAMMERED STAINLESS STEEL

DIMENSION	CODE
L 55 X W 15 X H 3 CM	1029170

NEW



ROUND COUPE

HAMMERED STAINLESS STEEL

DIMENSION	CODE
Ø 36 X H 6 CM	1029171



ROUND

HAMMERED STAINLESS STEEL

DIMENSION	CODE
Ø 14 X H 4 CM	1029172
Ø 30.5 X H 8 CM	1035877



OVAL

HAMMERED STAINLESS STEEL

DIMENSION	CODE
L 37.2 X W 28.8 X H 11 CM	1035879



SQUARE

HAMMERED STAINLESS STEEL

DIMENSION	CODE
L 25 X W 25 X H 9.7 CM	1029166



IRREGULAR SQUARE

HAMMERED STAINLESS STEEL

DIMENSION	CODE
L 18.5 X W 18.5 X H 7 CM	1029116



RECTANGULAR

HAMMERED STAINLESS STEEL

DIMENSION	CODE
L 29.2 X W 15 X H 7.4 CM	1029167



TRIANGULAR

HAMMERED STAINLESS STEEL

DIMENSION	CODE
L 30 X W 30 X H 8.8 CM	1035878



OBLONG

HAMMERED STAINLESS STEEL

DIMENSION	CODE
L 38 X W 14.5 X H 2.5 CM	1029169



OBLONG COUPE

HAMMERED STAINLESS STEEL

DIMENSION	CODE
L 51.5 X W 20.1 X H 12 CM	1029157



ALMOND

HAMMERED STAINLESS STEEL

DIMENSION	CODE
L 32.4 X W 16.5 X H 6 CM	1029156



FLOWER

HAMMERED STAINLESS STEEL

DIMENSION	CODE
L 33.5 X W 33.5 X H 13 CM	1029163



TRAPEZIUM

HAMMERED STAINLESS STEEL

DIMENSION	CODE
L 27.6 X W 14.4 X H 6 CM	1029158



TEAR DROP

HAMMERED STAINLESS STEEL

DIMENSION	CODE
L 40 X W 24 X H 16 CM	1029165





SQUARE
PORCELAIN

DIMENSION	CODE
L 12 X W 12 X H 3.5 CM	1020847
L 15 X W 15 X H 7 CM	1016052
L 20 X W 20 X H 6.8 CM	1047690
L 25 X W 25 X H 7 CM	1045342



SQUARE
PORCELAIN

DIMENSION	CODE
L 20 X W 20 X H 5 CM	1025738
L 20 X W 20 X H 7 CM	1025739



SQUARE
PORCELAIN

DIMENSION	CODE
L 20 X W 20 X H 10 CM	1033576
L 25 X W 25 X H 12 CM	1033577



SQUARE
PORCELAIN

DIMENSION	CODE
L 21 X W 21 X H 8.7 CM	1057127
L 23 X W 23 X H 10 CM	1057793
L 25 X W 25 X H 10.5 CM	1008568



ANGULAR
PORCELAIN

DIMENSION	CODE
Ø 22 X H 9 CM	1008682
Ø 29 X H 14 CM	1008565

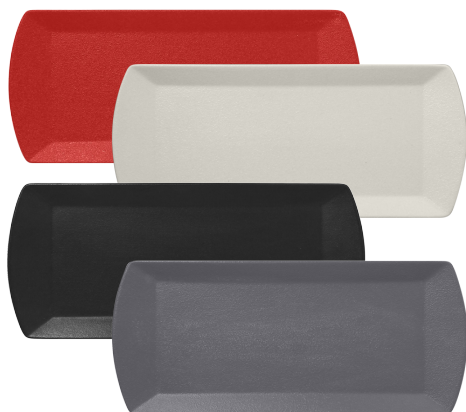

NEOFUSION OBLONG PLATE
PORCELAIN

NEW

COLOR	DIMENSION	CODE
BRIGHT RED	L 35 X W 15 CM	1064473
WHITE	L 35 X W 15 CM	1064517
BLACK	L 35 X W 15 CM	1064617
GREY	L 35 X W 15 CM	1064665



ROUND NON STACKABLE
PORCELAIN

DIMENSION	CODE
Ø 16 X H 7.5 CM	1004736
Ø 20 X H 8.3 CM	1004737
Ø 25 X H 10.5 CM	1004738
Ø 31 X H 13 CM	1004739



ROUND STACKABLE
PORCELAIN

DIMENSION	CODE
Ø 16 X H 7 CM	1004733
Ø 18 X H 6.5 CM	1004734
Ø 21 X H 7.5 CM	1004735



XXL
PORCELAIN

DIMENSION	CODE
Ø 31 X H 17 CM	1009347



COUPE
PORCELAIN

DIMENSION	CODE
Ø 26 X H 4.5 CM	1016328
Ø 30 X H 5 CM	1016312
Ø 36 X H 7 CM	1008567
Ø 46 X H 7.2 CM	1008680



MATRIX
PORCELAIN

DIMENSION	CODE
Ø 27 X H 7.5 CM	1012588
Ø 31 X H 8.3 CM	1012587
Ø 37 X H 13 CM	1020848



TWIN DIVIDER DISH
PORCELAIN

	DIMENSION	CODE
A	L 18 CM X W 20 X H 6 CM	1031743
B	L 18 CM X W 20 X H 6 CM	1031744
C	L 27 CM X W 20 X H 6 CM	1031742

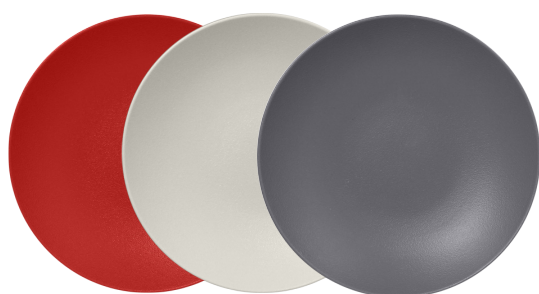

NEOFUSION COUPE BOWL **NEW**
PORCELAIN

COLOR	DIMENSION	CODE
BRIGHT RED	Ø 30 CM	1064452
WHITE	Ø 30 CM	1064496
GREY	Ø 30 CM	1064644



OVAL PLATTER
PORCELAIN

DIMENSION	CODE
L 56 X W 21 CM	1008566



NATURE ISLAND PLATTER
PORCELAIN

DIMENSION	CODE
L 33 X W 27.5 CM	1013288
L 39 X W 31 CM	1013289



OVAL DISH
PORCELAIN

DIMENSION	CODE
L 24 X W 14.3 X H 4.2 CM	1016329
L 29.5 X W 17.5 X H 5.5 CM	1016330
L 36 X W 22 X H 5 CM	1020919
L 40 X W 23 X H 5 CM	1016331



OVAL DISH
PORCELAIN

DIMENSION	CODE
L 25 X W 18 X H 5 CM	1008930
L 28 X W 19 X H 6 CM	1008681
L 30 X W 21 X H 6 CM	1020607
L 37 X W 26 X H 6 CM	1013297



TUREEN WITH LID
PORCELAIN

DIMENSION	CAP.	CODE
L 16 X W 13 X H 10 CM	60 CL	1028759
L 20 X W 15 X H 11.5 CM	104 CL	1028763
L 23 X W 18 X H 13 CM	160 CL	1028764



CASSEROLE WITH LID
PORCELAIN

DIMENSION	CODE	CODE
Ø 21 X H 14 CM	137 CL	1012045
Ø 23 X H 16 CM	217 CL	1012046
Ø 27 X H 18 CM	345 CL	1012047

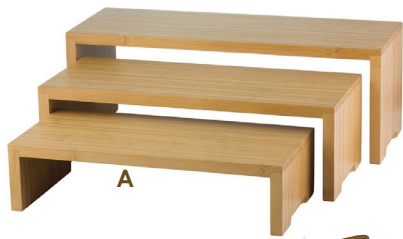

NEW



BUFFET CASCADE RISERS

SET OF 3

SMALL (43.2 X 17.8 X H 10.1 CM)
 MEDIUM (48.2 X 17.8 X H 15.2 CM)
 LARGE (55.9 X 17.8 X H 17.8 CM)

	ITEM	CODE
A	BAMBOO	1072975
B	ACACIA	1072976

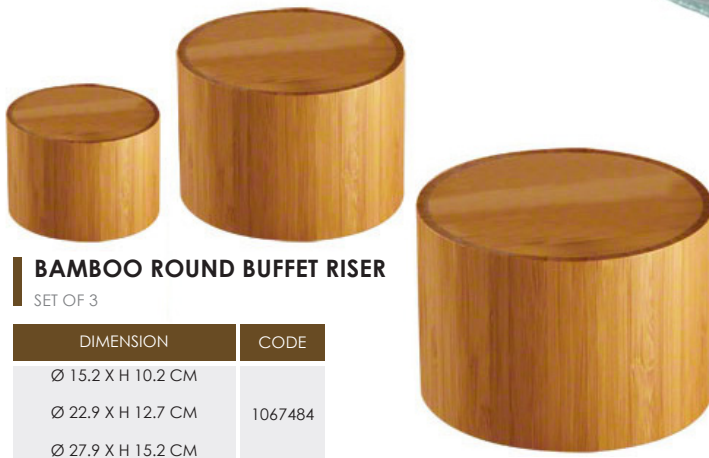

BAMBOO ROUND BUFFET RISER

SET OF 3

DIMENSION	CODE
Ø 15.2 X H 10.2 CM	
Ø 22.9 X H 12.7 CM	1067484
Ø 27.9 X H 15.2 CM	



BAMBOO RECTANGULAR BUFFET RISER

SET OF 3

DIMENSION	CODE
12.7 X 12.7 X 6.4 CM	
17.8 X 17.8 X 12.1 CM	1067483
22.9 X 22.9 X 16.2 CM	



ACRYLIC BUFFET RISER

SET OF 3

DIMENSION	CODE
12.7 X 12.7 CM	
17.8 X 17.8 CM	1032736
22.9 X 22.9 CM	

WOODEN BUFFET RISER

BLACK, SET OF 3

DIMENSION	CODE
12.7 X 12.7 CM	
17.8 X 17.8 CM	1026497
22.9 X 22.9 CM	





NEW

SQUARE WRITE-ON RISER

BAMBOO

DIMENSION	CODE
10 X 10 X H 14 CM	1067885
15.2X 15.2XH 17.8 CM	1067886



NEW

RECTANGULAR WRITE-ON RISER

BAMBOO

DIMENSION	CODE
W33X L20.3 X H 17.8 CM	1067887



NEW

ROUND WRITE-ON RISER

BAMBOO

DIMENSION	CODE
D12.7 X H 12.7 CM	1067888
D15 X H 20.3 CM	1067889
D23 X H 25.4 CM	1067890



NEW

ROUND WRITE-ON CUTLERY HOLDER

BAMBOO

DIMENSION	CODE
D12.7 X H 17.8 CM	1072344



NEW

SQUARE WRITE-ON CUTLERY HOLDER

BAMBOO

DIMENSION	CODE
10.2 X 10.2 XH 17.8 CM	1072345



NEW

RISER RUSTIC WITH CHALKBOARD

WOOD SET OF 3

DIMENSION	CODE
L 39 X W 30 X H 16 CM	1072354



NEW

RISER RUSTIC WITH CHALKBOARD

WHITE DISTRESSED WOOD SET OF 3

DIMENSION	CODE
L 39 X W 30 X H 16 CM	1072355





FOLD-A-WAY RISER
BAMBOO, SET OF 3

	DIMENSION	CODE
SMALL	26 X 26 X H 19 CM	1072356
MEDIUM	37 X 37 X H 28 CM	
LARGE	42 X 42 X H 38 CM	

FOLD-A-WAY RISER
BLACK WOOD, SET OF 3

	DIMENSION	CODE
SMALL	26 X 26 X H 19 CM	1072357
MEDIUM	37 X 37 X H 28 CM	
LARGE	42 X 42 X H 38 CM	

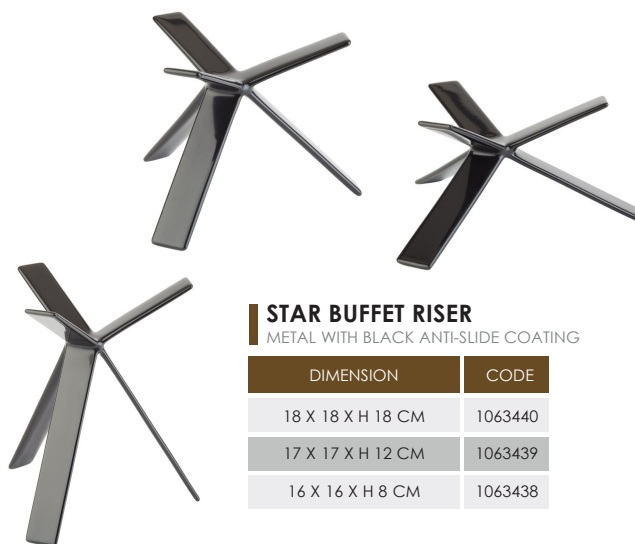

STAR BUFFET RISER
METAL WITH BLACK ANTI-SLIDE COATING

DIMENSION	CODE
18 X 18 X H 18 CM	1063440
17 X 17 X H 12 CM	1063439
16 X 16 X H 8 CM	1063438

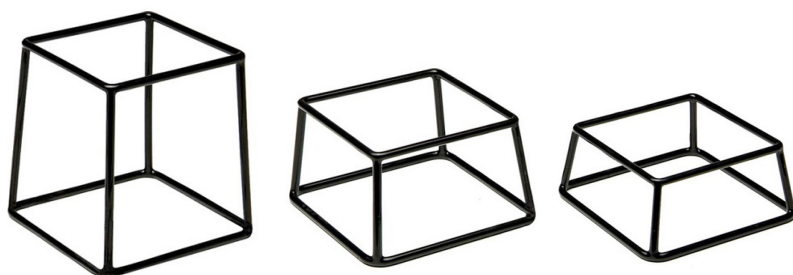

MULTI BUFFET RISER
METAL WITH BLACK ANTI-SLIDE COATING

DIMENSION	CODE
18 X 18 X H 18 CM	1048576
18 X 18 X H 10 CM	1044132
18 X 18 X H 8 CM	1049992



KING BUFFET RISER
STAINLESS STEEL

DIMENSION	CODE
Ø 15 X H 21 CM	1050913
Ø 15 X H 14 CM	1050912





LUMIO

PLEXIGLASS
WHITE FROSTED TRAY ON TWO ENLIGHTENED FEET
AUTONOMY 8 TO 10 HOURS

DIMENSION	CODE
L 48 X W 32.5 X H 30 CM	1037396
L 48 X W 32.5 X H 15 CM	1037395



LUMIKUB

PLEXIGLASS
WHITE FROSTED CUBE DIFFUSING AN
HOMOGENEOUS LIGHT WITH 48 LED SPOTLIGHT
AUTONOMY 8 TO 10 HOURS

DIMENSION	CODE
L 28 X W 28 X H 28 CM	1037397

NEW



2 TIER BUFFET STAND
STAINLESS STEEL, DELIVERED WITHOUT BASKET

DIMENSION	CODE
L 46 X W 24 X H 21 CM	1047028



BUFFET STAND CASUAL

WITHOUT BOWL

DIMENSION	CODE
Ø 48 X H 49 CM	1057131

BASKET FOR 1047028

BEIGE, POLYPROPYLENE



SIZE	DIMENSION	HEIGHT	CODE
GN 1/2	L 32.5 X W 26.5 CM	6.5 CM	1050296
GN 1/2	L 32.5 X W 26.5 CM	10 CM	1044526



BLACK, POLYPROPYLENE

SIZE	DIMENSION	HEIGHT	CODE
GN 1/2	L 32.5 X W 26.5 CM	6.5 CM	1051294
GN 1/2	L 32.5 X W 26.5 CM	10 CM	1052129



BANQUET STACKABLE BOWL FOR 1057131

PORCELAIN

DIMENSION	CODE
Ø 21 X H 7.5 CM	1004735

ROUND BASKET FOR 1057131

BEIGE, POLYPROPYLENE



DIMENSION	CODE
Ø 20 X H 8 CM	1053085



BUFFET STAND FLOAT SMALL

WITHOUT BOWL

DIMENSION	CODE
L 55.5 X W 19 CM	1055290



SQUARE BOWL FOR 1055290

PORCELAIN

DIMENSION	CODE
L 20 X W 20 X H 6.8 CM	1047690



SQUARE BOWL FOR 1055290

PORCELAIN

DIMENSION	CODE
L 20 X W 20 X H 10 CM	1033576



BUFFET RISER SQUARE
STAINLESS STEEL

DIMENSION	CODE
26 X 26 X H 26 CM	1055198
20 X 20 X H 20 CM	1052329
17 X 17 X H 17 CM	1052408
14 X 14 X H 14 CM	1052330
11 X 11 X H 11 CM	1052331



CUBE BUFFET RISER
BRUSHED STAINLESS STEEL

DIMENSION	CODE
10 X 10 X 20 CM	1063573
10 X 10 X 30 CM	1063574
20 X 20 X 10 CM	1063575

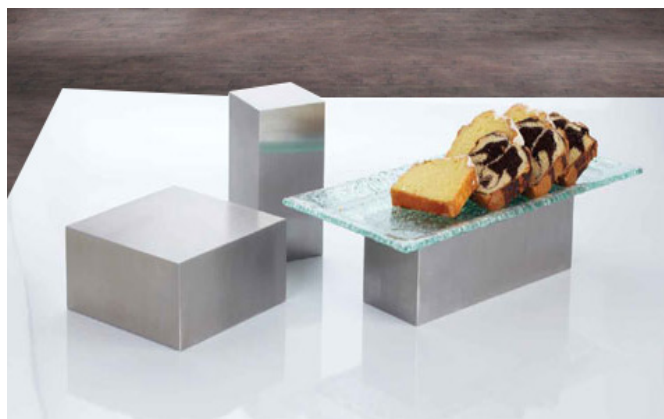

HAMMERED STEMMED STAND
STAINLESS STEEL

DIMENSION	CODE
25.5 X 25.5 X H 22 CM	1029174



HAMMERED ROUND RISER
STAINLESS STEEL

DIMENSION	CODE
Ø 14 X H 6 CM	1029175
Ø 14 X H 10.5 CM	1029176



HAMMERED SQUARE RISER
STAINLESS STEEL

DIMENSION	CODE
15 X 15 X H 10.5 CM	1029178
15 X 15 X H 6 CM	1029177



**MAJESTIC SET OF 3
ADJUSTABLE GREY GLASS TRAYS**

DIMENSION	CODE
L50 X W51 X H14 CM	1071605



**ACRYLIC FOUR STEPS
WATERFALL**

DIMENSION	CODE
L 39X W 30X H16 CM	1072353



ACRYLIC RISERS

SET OF 3

DIMENSION	CODE
40 X 14 X H 2.5 CM	1072421
40 X 13 X H 7.6 CM	
40 X 13 X H 12.7CM	



ACRYLIC RISER

DIMENSION	CODE
40 X 30 X H 5.7 CM	1072422



MIRROR BUFFET PLATTER

SILVER MIRROR GLASS
NON-SLIP FEET

DIMENSION	SIZE	CODE
L 53 X W 32.5 X H 3 CM	GN 1/1	1051246
L 32.5 X W 26.5 X H 3 CM	GN 1/2	1056473
L 32.5 X W 17.6 X H 3 CM	GN 1/3	1061756
L 53 X W 16.2 X H 3 CM	GN 2/4	1061757



CURL RISER SET

SATIN STAINLESS STEEL, PACK OF 3

DIMENSION	CODE
L 21 X W 10.2 X H 5.1 CM	1067468
L 26.7 X W 13.3 X H 10.2 CM	
L 31.8 X W 15.2 X H 16.5 CM	



NEW



PARTHENON BUFFER RISER
POLISHED CHROME

DIMENSION	CODE
Ø 15 X H 10.5 CM	1072503
Ø 21 X H 20 CM	1069771



NEW



PARTHENON BUFFER RISER
BRUSHED GOLD

DIMENSION	CODE
Ø 15 X H 10.5 CM	1072504
Ø 21 X H 20 CM	1072505



STRIPES BUFFET STAND
STAINLESS STEEL

DIMENSION	SIZE	CODE
Ø 42 X H 10 CM	ROUND	1026478
L 56 X W 34.2 X H 15 CM	GN 1/1	1026479
L 35.3 X W 28.6 X H 10 CM	GN 1/2	1026480



PORCELAIN INSERT FOR 1026478

	DIMENSION	CODE
A	Ø 39 CM X H 6.2 CM	1007708
B	Ø 39 CM X H 6.2 CM	1009591



PORCELAIN INSERT FOR 1026479

	DIMENSION	CODE
A	GN 1/1 - H 2 CM	1020138
B	GN 1/1 - H 6.5 CM	1007705
C	GN 1/1 - H 6.5 CM	1069054
D	GN 1/1 - H 6.5 CM	1069055

NEW
NEW



PORCELAIN INSERT FOR 1026480

	DIMENSION	CODE
A	GN 1/2 - H 2.2 CM	1031544
B	GN 1/2 - H 6.5 CM	1007706
C	GN 1/2 - H 6.5 CM	1069056

NEW



FRUIT BASKET WITH HANDLE
STAINLESS STEEL

DIMENSION	CODE
24 X 24 X H 21 CM	1072224



FRUIT BASKET WITH HANDLE
COPPER

DIMENSION	CODE
24 X 24 X H 21 CM	1072225



HAMMERED FOOD DISPLAY
STAINLESS STEEL

DIMENSION	CODE
L 43 X W 30 X H 41 CM	1029149



FRUIT DISPLAY
STAINLESS STEEL

DIMENSION	CODE
Ø 32 X H 53 CM	1058853



FRUIT BASKET
STAINLESS STEEL

DIMENSION	CODE
Ø 21.5 X H 20.5 CM	1053301





Juice Dispenser

Skycap
Multi Level Riser

Finishing Cap
for Skycap Riser

Shelf



Drawer

*Cereal
Dispenser*

*Condiment
Tray*



SQUARE JUICE DISPENSER

BAMBOO BASE

NEW

DIMENSION	CAPACITY	CODE
17.1 X 17.1 X H 59.1 CM	7 LTR	1072705
18.4 X 18.4 X H 43.2 CM	3.8 LTR	1072704



NEW

SQUARE DRIP TRAY

ACRYLIC / STAINLESS STEEL

DIMENSION	CODE
10.8 X 10.8 X H 2.5 CM	1072706



NEW

SKYCAP MULTI LEVEL RISER

BAMBOO

DIMENSION	CODE
17.1 X 17.1 X H 15.2 CM	1072698
17.1 X 17.1 X H 30.5 CM	1072699

FINISHING CAP FOR SKYCAP RISER

BAMBOO

DIMENSION	CODE
17.1 X 17.1 CM	1072700



NEW

BAMBOO SHELF

DIMENSION	CODE
L 86.4 X W 35.6 CM	1071982
L 86.4 X W 20.3 CM	1072702
35.6 X 35.6 CM	1071980



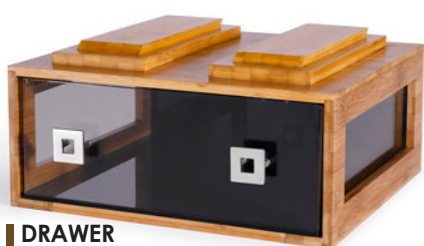

DRAWER
BAMBOO

DIMENSION	CODE
L 40.6 X W 37.5 X H 19 CM	1072723

NEW



DRAWER
BAMBOO

DIMENSION	CODE
L 20.3 X W 35.6 X H 19 CM	1071979

NEW



FINISHING CAP FOR DRAWER
BAMBOO

DIMENSION	CODE
L 20.3 X W 37.5 CM	1072697

NEW



NEW

CONDIMENT TRAY
BAMBOO

DIMENSION	CODE
L 20.3 X W 37.5 X H 15.2 CM	1072703



NEW

CONDIMENT TRAY
BAMBOO

DIMENSION	CODE
L 40.6 X W 37.5 X H 15 CM	1072724



NEW

TRIPLE CEREAL DISPENSER

DIMENSION	CAPACITY	CODE
L 53.3 X W 22.9 X H 66 CM	3 X 4.9 LTR	1072708

SINGLE CEREAL DISPENSER

DIMENSION	CAPACITY	CODE
L 23.5 X W 22.9 X H 66 CM	4.9 LTR	1072707

NEW





NEW

BAMBOO SHELF

DIMENSION	CODE
L 86.4 X W 35.6 CM	1071982
L 86.4 X W 20.3 CM	1072702
35.6 X 35.6 CM	1071980



NEW

**BASE COLUMN
MULTI LEVEL RISER**

BAMBOO BASE

DIMENSION	CODE
35 X 35 X H 57.2 CM	1072701

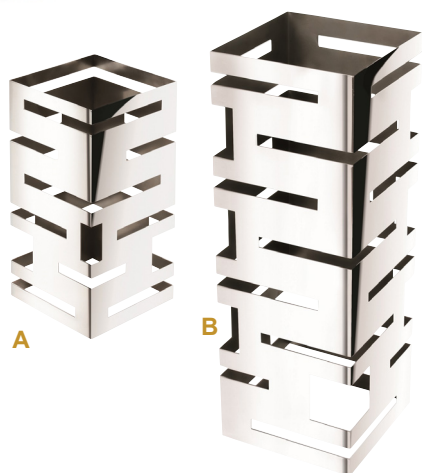

MULTI LEVEL SQUARE BUFFET RISER

STAINLESS STEEL, MIRROR FINISH

	DIMENSION	CODE
A	15 X 15 X H 33 CM	1065900
B	18 X 18 X H 50 CM	1065901
C	20 X 20 X H 70 CM	1065902



**MULTI LEVEL ROUND
BUFFET RISER**

STAINLESS STEEL, MIRROR FINISH

DIMENSION	CODE
Ø 17 X H 31 CM	1065903

NEW

**SMART & GREEN
LED MODULE**



	POWER	VOLTAGE	CODE
LED MODULE	1.2W	5V - 50/60HZ	1068482
CHARGER			1068481



TEMPERED GLASS TRAY

FOR MULTI LEVEL BUFFET RISER

DIMENSION	CODE
L 35.5 X W 35.5 CM	1066057
L 85 X W 35.5 CM	1066056
L 85 X W 19.5 CM	1066055



TEMPERED GLASS TRAY

FOR MULTI LEVEL BUFFET RISER

DIMENSION	CODE
Ø 50.5 CM	1066059
Ø 35.5 CM	1066058

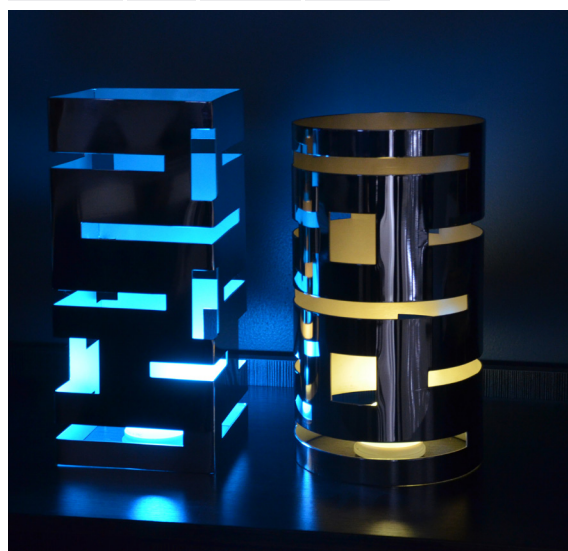



RECTANGULAR BUFFET RISER
OAK craster

DIMENSION	CODE
40 X 21 X H 8 CM	1037642



SQUARE BUFFET RISER
OAK craster

DIMENSION	CODE
21 X 21 X H 10 CM	1037626
21 X 21 X H 14 CM	1037625
21 X 21 X H 17 CM	1037624



THREE STEP RISER
OAK craster

DIMENSION	CODE
40 X 25 X H 9 CM	1050721



RUSTIC RISER
OAK craster

DIMENSION	CODE
15 X 15 X H 15 CM	1044427
20 X 20 X H 20 CM	1044426



PATISSERIE GRAND RISER
OAK

DIMENSION	CODE
53 X 32.5 X H 8 CM	1062946



PATISSERIE RISER
OAK

DIMENSION	CODE
32.5 X 32.5 X H 18 CM	1062950
32.5 X 32.5 X H 11.5 CM	1062949
32.5 X 32.5 X H 8 CM	1062948



FRUIT STAND FIVE TIERS
OAK craster

DIMENSION	CODE
L 57 X W 55.5 X H 189 CM	1044124



THREE TIER STAND LARGE
OAK craster

DIMENSION	CODE
39.5 X 39.5 X H 33 CM	1044119



THREE TIER STAND NARROW
OAK

DIMENSION	CODE
L 39.5 X W 19.7 X H 33 CM	1058486



THREE TIER STAND MINI
OAK craster

DIMENSION	CODE
L 28 X W 22 X H 22 CM	1058485



FRUIT STAND TWO TIERS
OAK craster

DIMENSION	CODE
L 45 X W 33.6 X H 60 CM	1037622



RUSTIC FRUIT BOX
OAK craster

DIMENSION	CODE
L 33 X W 33 X H 5 CM	1044120
L 40 X W 30 X H 6 CM	1044121
L 50 X W 30 X H 18 CM	1044122



MULTI CHEF BASE LOW



DIMENSION	MATERIAL	CODE
L 54.9 X W 34.5 X H 17.8 CM	STAINLESS STEEL	1072887
L 54.9 X W 34.5 X H 17.8 CM	BLACK MATT	1072886



MULTI CHEF BASE TALL

3 FUEL HOLDERS



DIMENSION	MATERIAL	CODE
L 54.9 X W 34.5 X H 25.4 CM	STAINLESS STEEL	1072891
L 54.9 X W 34.5 X H 25.4 CM	BLACK MATT	1072890



MULTI CHEF BASE MEDIUM

3 FUEL HOLDERS



DIMENSION	MATERIAL	CODE
L 54.9 X W 34.5 X H 20.3 CM	STAINLESS STEEL	1072889
L 54.9 X W 34.5 X H 20.3 CM	BLACK MATT	1072888



MULTI CHEF SINGLE INDUCTION

BAMBOO SURFACE WITH 4 MAGNETS



DIMENSION	POWER	VOLTAGE	CODE
L 54.8 X W 34.5 X H 4.0 CM	600W	220/240 V	1072884



MULTI CHEF DOUBLE INDUCTION

BAMBOO SURFACE WITH 8 MAGNETS



DIMENSION	POWER	VOLTAGE	CODE
L 54.8 X W 34.5 X H 4.0 CM	1200W	220/240V	1072885





NEW

MULTI CHEF FLAT BOARD
BAMBOO



DIMENSION	CODE
L 54.3 X W 34.5 X H 3.5 CM	1072893



NEW

MULTI CHEF BREAD BOARD
BAMBOO



DIMENSION	CODE
L 54.3 X W 34.5 X H 4 CM	1072895



NEW

MULTI CHEF CARVING BOARD
BAMBOO



DIMENSION	CODE
L 54.8 X W 34.5 X H 4 CM	1072894



NEW

MULTI CHEF CUTLERY BOARD
BAMBOO



DIMENSION	CODE
L 54.8 X W 34.5 X H 4 CM	1072896



NEW

MULTI CHEF TRACK GRILL
STAINLESS STEEL



DIMENSION	CODE
L 61 X W 30.5 X H 1.9 CM	1072892



NEW

MULTI CHEF ICE TUB
ACRYLIC



DIMENSION	CODE
L 62.2 X W 34.3 X H 12.1 CM	1072897

FLOW™

craster

CRASTER'S NEW MODULAR DISPLAY SYSTEM

FLOW IS A DYNAMIC SYSTEM OF DISPLAY UNITS, ORGANISED AROUND A MODULAR GASTRONORM FOOTPRINT. THE SYSTEM GIVES YOU THE FLEXIBILITY TO SHOWCASE YOUR CREATIVITY IN A MULTITUDE OF CONTEXTS.

THE TWO RANGES, RUSTIC (OAK) AND REFINE (WALNUT), ARE COMPRISED OF MATERIALS AND MODULAR COMPONENTS THAT PROVIDE THE VERSATILITY TO TAILOR YOUR DISPLAY TO THE SPECIFIC REQUIREMENTS OF EACH EVENT.

FLOW'S INTERCHANGEABLE AND STACKABLE COMPONENTS



TRAY SIZES



GN 1/4

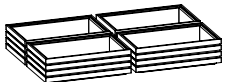

GN 1/4 TALL



GN 3/9



GN 2/4



GN 1/2

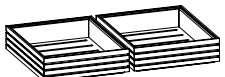

GN 1/2 TALL



GN 1/1



GN 1/1 TALL

TRAY AND ELEVATION COMBINATIONS



1 TRAYS + TRAYS

A RANGE OF MODULAR GASTRONORM SIZED TRAYS (1/1, 1/2, 1/4, 2/4, 3/9) TRAYS ARE DESIGNED TO INTERLOCK ENABLING A HUGE RANGE OF DISPLAY OPTIONS STORAGE IS EASY AND COMPACT ALL TRAYS SLOT TOGETHER TO CREATE A SINGLE COMPACT STACK



2 TRAYS + FRAMES

A RANGE OF POLISHED SOLID STAINLESS STEEL FRAMES THAT ENABLE A SOPHISTICATED VERSATILE BUFFET DISPLAY VARYING HORIZONTAL AND ANGLED HEIGHTS

3



3 TRAYS + TROLLEYS / STANDS

FLOW TRAYS ARE DESIGNED TO BE DEPLOYED SEAMLESSLY ACROSS A RANGE OF MOBILE POINT OF SALE TROLLEYS AND STANDS STANDS ARE DESIGNED TO ENABLE TRAY REPLENISHMENT BACK OF HOUSE, AND FACILITATE THE USE OF DIFFERENT TRAY SIZES AND DEPTHS ACCORDING TO DEMAND



FLOW RUSTIC TRAY GN 1/1

OAK, OILED

DIMENSION	CODE
53 X 32.5 X 4 CM	1058479
53 X 32.5 X 7.5 CM	1058483



FLOW RUSTIC TRAY GN 1/2

OAK, OILED

DIMENSION	CODE
32.5 X 26.5 X H 4 CM	1058480
32.5 X 26.5 X H 7.5 CM	1060637



FLOW RUSTIC TRAY GN 1/4

OAK, OILED

DIMENSION	CODE
26 X 16.25 X H 4 CM	1060636
26 X 16.25 X H 7.5 CM	1058484



FLOW RUSTIC TRAY GN 2/4

OAK, OILED

DIMENSION	CODE
53 X 16.25 X H 4 CM	1058481



FLOW RUSTIC TRAY GN 3/9

OAK, OILED

DIMENSION	CODE
53 X 10.8 X H 4 CM	1058482



NEW



FLOW BLACK TRAY GN 1/1

DIMENSION	CODE
53 X 32.5 X H 4 CM	1073062
53 X 32.5 X H 7.5 CM	1073065



NEW



FLOW BLACK TRAY GN 1/2

DIMENSION	CODE
32.5 X 26.5 X H 4 CM	1073063
32.5 X 26.5 X H 7.5 CM	1073066



FLOW BLACK TRAY GN 1/4

DIMENSION	CODE
26 X 16.25 X H 7.5 CM	1073067



FLOW BLACK TRAY GN 2/4

DIMENSION	CODE
53 X 16.25 X H 4 CM	1073064



NEW



FLOW WHITE WASHED TRAY GN 1/1

DIMENSION	CODE
53 X 32.5 X H 4 CM	1073068
53 X 32.5 X H 7.5 CM	1073071



NEW



FLOW WHITE WASHED TRAY GN 1/2

DIMENSION	CODE
32.5 X 26.5 X H 4 CM	1073069
32.5 X 26.5 X H 7.5 CM	1073072



NEW



FLOW WHITE WASHED TRAY GN 1/4

DIMENSION	CODE
26 X 16.25 X H 7.5 CM	1073073



NEW



FLOW WHITE WASHED TRAY GN 2/4

DIMENSION	CODE
53 X 16.25 X H 4 CM	1073070



FLOW REFINE TRAY

WALNUT, MATT LACQUER

	DIMENSION	CODE
GN 1/1	53 X 32.5 X H 4 CM	1060638
GN 1/2	32.5 X 26.5 X H 4 CM	1060639
GN 1/4	26.5 X 16.25 X H 4 CM	1060640





CLEAR GLASS TRAY

	DIMENSION	CODE
GN 1/1	L 53 X W 32.5 X H 1 CM	1060641
GN 1/2	L 32.5 X W 26.5 X H 1 CM	1060642
GN 2/4	L 53 X W 16.3 X H 1 CM	1058487



BLACK GLASS TRAY

	DIMENSION	CODE
GN 1/1	L 53 X W 32.5 X H 1 CM	1066089
GN 1/2	L 32.5 X W 26.5 X H 1 CM	1066011
GN 2/4	L 53 X W 16.3 X H 1 CM	1066010

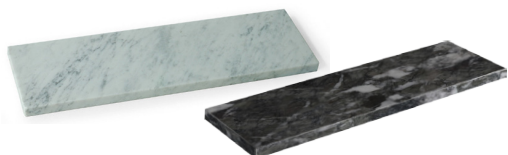

MARBLE TRAY GN 2/4

	DIMENSION	CODE
WHITE	L 53 X W 16.25 X H 2 CM	1060643
GREY	L 53 X W 16.25 X H 2 CM	1066012



NEW

FLOW LABEL HOLDER



	DIMENSION	CODE
BRUSHED BRASS	FIT WITHIN 1.3 TRAY	1074497
BRUSHED STEEL	FIT WITHIN 1.3 TRAY	1074868



A



B



C



D



E



F



G



H



I



J

FRAME

STAINLESS STEEL, POLISHED

		DIMENSION	CODE
A	HIGH	L 53 X W 32.5 X H 18.45 CM	1060644
B	LOW	L 53 X W 32.5 X H 9.95 CM	1060645
C	TILTED HIGH	L 53 X W 31.4 X H 18.2 CM	1060646
D	TILTED LOW	L 53 X W 31.5 X H 9.7 CM	1060647
E	NARROW HIGH	L 32.5 X W 26.5 X H 18.45 CM	1060648
F	NARROW LOW	L 32.5 X W 26.5 X H 9.95 CM	1060649
G	NARROW TILTED HIGH	L 31.4 X W 26.5 X H 18.2 CM	1060650
H	NARROW TILTED LOW	L 31.5 X W 26.5 X H 9.7 CM	1060651
I	PLINTH HIGH	L 53 X W 16.3 X H 18.5 CM	1060652
J	PLINTH LOW	L 53 X W 16.3 X H 10 CM	1060653





A

B



C



D



A



B



C



D



E

STAND

OAK, OILED

craster

	ITEM	DIMENSION	CODE
A	TWO TIER - NARROW	L 30.9 X W 32.3 X H 44.1 CM	1060654
B	TWO TIER	L 57.4 X W 32.3 X H 44.1 CM	1060655
C	FOUR TIER	L 57.4 X W 40 X H 119.7 CM	1060656
D	FIVE TIER	L 57.4 X W 40 X H 145.9 CM	1060657

TROUGH

OAK, OILED

craster

	ITEM	DIMENSION	CODE
A	TRAY	L 26.5 X W 25 X H 16 CM	1060661
B	TRAY GN 1/1	L 53 X W 25 X H 16 CM	1060660
C	TRAY DEEP GN 1/1	L 53 X W 25 X H 20 CM	1060662
D	FLOW TROUGH SHORT	L 57.4 X W 25 X H 43.2 CM	1060659
E	FLOW TROUGH TALL	L 57.4 X W 25 X H 85.7 CM	1060658



A

B

TROLLEY

OAK, OILED

craster

	ITEM	DIMENSION	CODE
A	SINGLE	L 82.1 X W 70 X H 96 CM	1061719
B	DOUBLE	L 135.6 X W 70 X H 96 CM	1061718



BANQUET TABLES

craster

CRASTER'S NEW SUPERBLY VERSATILE FLEXIBLE BUFFET TABLE SYSTEM ENABLES BANQUETING TEAMS TO RESPOND QUICKLY TO THE NEEDS OF CLIENTS, WITHOUT THE NEED FOR EXPENSIVE CLOTH TABLE COVERS. THIS INTELLIGENTLY ENGINEERED TABLE SYSTEM COMPRISES A MODULAR RANGE OF TABLE HEIGHTS AND FOOT PRINTS THAT ALLOW EASY ASSEMBLY AND DISASSEMBLY WITH EASE AND COMPACT STORAGE.

4 STEPS TO CREATING YOUR TABLE COLLECTION

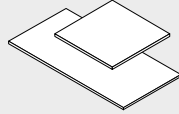
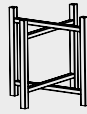

1. CHOOSE A SERIES
700MM OR 800MM

2. CHOOSE YOUR LEGS
HEIGHT AND MATERIAL

3. CHOOSE YOUR TOPS
SHAPE AND MATERIAL

4. CHOOSE YOUR
TROLLEYS

TABLE LEGS



STAINLES STEEL TABLE LEGS



700 SERIES
DIMENSION - L 51 X W 51 CM

HEIGHT	CODE
119 CM	1058130
89 CM	1058129
69 CM	1058128

800 SERIES
DIMENSION - L 57 X W 57 CM

HEIGHT	CODE
119 CM	1056750
89 CM	1056749
69 CM	1056748

OAK STAINED WENGE TABLE LEGS



700 SERIES
DIMENSION - L 52 X W 52 CM

HEIGHT	CODE
119 CM	1044129
89 CM	1044128
69 CM	1054313

800 SERIES
DIMENSION - L 58 X W 58 CM

HEIGHT	CODE
119 CM	1066150
89 CM	1066149
69 CM	1066148

NEW



MATT BLACK STEEL TABLE LEGS

700 SERIES
DIMENSION - L 51 X W 51 CM

HEIGHT	CODE
119 CM	1075004
89 CM	1075003
69 CM	1075002

800 SERIES
DIMENSION - L 57 X W 57 CM

HEIGHT	CODE
119 CM	1075007
89 CM	1075006
69 CM	1075005



TABLE TOPS



WENGE REEF EDGE HIGH PRESSURE LAMINATE

700 SERIES

DIMENSION	CODE
L 140 X W 70 X H 2.5 CM	1074999
L 70 X W 70 X H 2.5 CM	1074998

800 SERIES

DIMENSION	CODE
L 160 X W 80 X H 2.5 CM	1075001
L 80 X W 80 X H 2.5 CM	1075000

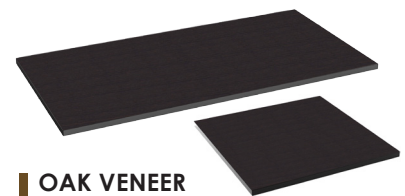

OAK VENEER STAINED WENGE

700 SERIES

DIMENSION	CODE
L 140 X W 70 X H 2.5 CM	1066143
L 70 X W 70 X H 2.5 CM	1066142

800 SERIES

DIMENSION	CODE
L 160 X W 80 X H 2.5 CM	1066154
L 80 X W 80 X H 2.5 CM	1066151



FROSTED GLASS

700 SERIES

DIMENSION	CODE
L 140 X W 70 X H 1 CM	1062914
L 70 X W 70 X H 1 CM	1062913

800 SERIES

DIMENSION	CODE
L 160 X W 80 X H 1 CM	1062915
L 80 X W 80 X H 1 CM	1066153



ROUND CLEAR GLASS

700 SERIES

DIMENSION	CODE
Ø 99 X H 1 CM	1066146

800 SERIES

DIMENSION	CODE
Ø 113 X H 1 CM	1066157



ROUND FROSTED GLASS

700 SERIES

DIMENSION	CODE
Ø 99 X H 1 CM	1066147

800 SERIES

DIMENSION	CODE
Ø 113 X H 1 CM	1066158



HALF ROUND CLEAR GLASS

700 SERIES

DIMENSION	CODE
L 140 X W 70 X H 1 CM	1063210



CLEAR GLAS

700 SERIES

DIMENSION	CODE
L 140 X W 70 X H 1 CM	1066145
L 70 X W 70 X H 1 CM	1054314

800 SERIES

DIMENSION	CODE
L 160 X W 80 X H 1 CM	1066156
L 80 X W 80 X H 1 CM	1056747



TROLLEYS



TROLLEY FOR TABLE LEG

FOR 8 TABLE LEGS
700 / 800 SERIES

CODE
1066139



TROLLEY FOR TABLE TOP

FOR 12 SQUARE GLASS
700 / 800 SERIES

CODE
1058131



TROLLEY FOR TABLE TOP

FOR 12 SQUARE WOOD
700 / 800 SERIES

CODE
1053081



TROLLEY FOR TABLE LEG

FOR 16 TABLE LEGS
700 / 800 SERIES

CODE
1053082



TROLLEY FOR TABLE TOP

FOR 6 RECTANGULAR GLASS
700 / 800 SERIES

CODE
1066140



TROLLEY FOR TABLE TOP

FOR 8 RECTANGULAR WOOD
700 / 800 SERIES

CODE
1066141

TACTUS BLACK TROLLEYS



TACTUS BASE TROLLEY

BLACK

2 PROFESSIONAL SOFT CLOSING DRAWERS WITH 1 REMOVABLE SHELF FOR PLATES
ALUMINIUM HANDLE
PROFESSIONAL MID-SOFT SWIVEL CASTORS ALL WITH BREAKS (Ø 125 MM)
ZEPETOUGH TECHNOLOGY: HYDROPHOBIC HIGH-TECH SURFACE TREATMENT WITH SELF CLEANING EFFECT
STRUCTURE IN WOOD WITH GALVANIZED ALUMINIUM LEGS



DIMENSION	CODE
L 99.5 X W 53 X H 80 CM	1029782

OTHER COLORS AVAILABLE ON REQUEST



TACTUS LIQUOR & WINE TROLLEY

BLACK

3 INSULATED STAINLESS STEEL BOTTLE COOLERS
1 BIG GLASS HOLDER RACK & 2 BOTTLE HOLDER ON THE LOWER LEVEL FOR 6 BOTTLES
2 PROFESSIONAL SOFT CLOSING DRAWERS WITH 1 REMOVABLE SHELF FOR PLATES
ALUMINIUM HANDLE
PROFESSIONAL MID-SOFT SWIVEL CASTORS ALL WITH BREAKS (Ø 125 MM)
ZEPETOUGH TECHNOLOGY: HYDROPHOBIC HIGH-TECH SURFACE TREATMENT WITH SELF CLEANING EFFECT
STRUCTURE IN WOOD WITH GALVANIZED ALUMINIUM LEGS



DIMENSION	CODE
L 99.5 X W 53 X H 104 CM	1027751

OTHER COLORS AVAILABLE ON REQUEST

TACTUS CHEESE TOP NOT CHILLED

BLACK



PE CUTTING BOARD L 64 X W 44 CM WITH HANDLES FOR CHEESE (NOT CHILLED) & ROLL TOP
TOP & BASE TROLLEY: L 93 X W 53 X H 109 CM
TACTUS BASE TROLLEY (1029782) TO BE ORDERED SEPARATELY



DIMENSION	CODE
L 93 X W 53 X H 29 CM	1026533

TACTUS CHAMPAGNE TOP

BLACK

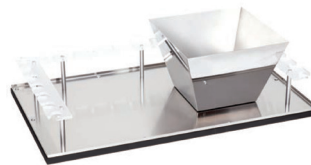

CHAMPAGNE BOWL INCLUDED
TACTUS BASE TROLLEY (1029782) TO BE ORDERED SEPARATELY



DIMENSION	CODE
L 93 X W 53 X H 30 CM	1060611

TACTUS SEA FOOD TOP

BLACK



REMOVABLE STAINLESS STEEL 18/10 TRAY FOR SEA FOOD ON CRUSHED ICE
TRAY INNER DIMENSION L 84 X W 44 X H 9.5 CM
TACTUS BASE TROLLEY (1029782) TO BE ORDERED SEPARATELY



DIMENSION	CODE
L 93 X W 53 X H 16 CM	1035568



TACTUS FLAMBE TROLLEY 1 BURNER

BLACK

GAS BURNER (BUTAN-PROPAN) WITH SAFETY VALVES, POWER: 1,5 KW, CE CERTIFIED, FLAME REGULATOR AND ELECTRIC IGNITION DEVICE (BATTERY)
WORKSPACE IN STAINLESS STEEL
1 BOTTLE HOLDER ON THE LOWER LEVEL FOR 3 BOTTLES
1 PROFESSIONAL SOFT CLOSING DRAWER WITH 1 REMOVABLE SHELF FOR PLATES
ALUMINIUM HANDLE
PROFESSIONAL MID-SOFT SWIVEL CASTORS ALL WITH BREAKS (Ø 125 MM)
ZEPETOUGH TECHNOLOGY: HYDROPHOBIC HIGH-TECH SURFACE TREATMENT WITH SELF CLEANING EFFECT
STRUCTURE IN WOOD WITH GALVANIZED ALUMINIUM LEGS



DIMENSION	CODE
L 99.5 X W 53 X H 85 CM	1024041

OTHER COLORS AVAILABLE ON REQUEST

TACTUS BLACK TROLLEYS



TACTUS CARVING TROLLEY

BLACK

ELECTRIC BAIN-MARIE TANK 1/1 + 1/2 GN, WATER CAP. APPROX. 10 LITRES WITH DRAIN FAUCETS (EASY WATER DISCHARGE)
 CE CERTIFIED / DIGITAL SETTABLE THERMOMETER / POWER: 1400W, 220-240V
 3 X GN PANS (GN1/1 + 2X GN 1/4) + PE CUTTING BOARD (GN1/1)
 HEATING CUT TEMPERATURE 60 °C, MAX. TEMPERATURE 80°C
 MAGNETO REVOLVING ROLL TOP COVER WITH 180° OPENING IN STAINLESS STEEL 18/10
 ALUMINIUM HANDLE
 PROFESSIONAL MID-SOFT SWIVEL CASTORS ALL WITH BREAKS (Ø 125 MM)



DIMENSION	CODE
L 103 X W 62 X H 103 CM	1038093

OTHER COLORS AVAILABLE ON REQUEST



TACTUS PASTRY TROLLEY

BLACK

4 LEVELS ROLL TOP (PMMA) WITH LOWER LEVEL WITH AUTOMATIC MOVEMENT
 LOWER LEVEL CHILLED WITH ICE PACK INCLUDED
 2 FOLDABLE PLATE HOLDER TRAYS IN STAINLESS STEEL 18/10
 2 BIG ALUMINIUM HANDLES
 4 PROFESSIONAL SWIVEL CASTORS ALL WITH BRAKES (Ø125 MM)
 ZEPETOUGH TECHNOLOGY: HYDROPHOBIC HIGH-TECH SURFACE TREATMENT WITH SELF CLEANING EFFECT
 STRUCTURE IN WOOD WITH GALVANIZED ALUMINIUM LEGS



DIMENSION	CODE
L 115 X W 52 X H 125 CM	1060612

OTHER COLORS AVAILABLE ON REQUEST



TACTUS TROLLEY 2 LEVELS

BLACK

TROLLEY 2 LEVELS
 PROFESSIONAL MID-SOFT SWIVEL CASTORS ALL WITH BREAKS (Ø 125 MM)
 ZEPETOUGH TECHNOLOGY: HYDROPHOBIC HIGH-TECH SURFACE TREATMENT WITH SELF CLEANING EFFECT
 STRUCTURE IN WOOD WITH GALVANIZED ALUMINIUM LEGS



DIMENSION	CODE
L 93 X W 53 X H 80 CM	1034028

OTHER COLORS AVAILABLE ON REQUEST



NATURE WALNUT TROLLEYS

NATURE BASE TROLLEY

WITH HANDLE

STRUCTURE IN 100% ITALIAN WALNUT HARDWOOD AND GALVANIZED ALUMINIUM LEGS
2 PROFESSIONAL SOFT CLOSING DRAWERS WITH 1 REMOVABLE SHELF FOR PLATES
1 BIG ALUMINIUM HANDLE
4 PROFESSIONAL MID-SOFT SWIVEL CASTORS ALL WITH BREAKS (Ø 125 MM)



NEW



DIMENSION	CODE
L 95.5 X W 53 X H 80 CM	1066182

NATURE SEA FOOD TOP

REMOVABLE STAINLESS STEEL 18/10 TRAY FOR SEA FOOD ON CRUSHED ICE
TRAY INNER DIMENSION 84 X 44 X H 9,5 CM
TOP & BASE TROLLEY 93 X 53 X H 96 CM
NATURE BASE TROLLEY 1066182 TO BE ORDERED SEPARATELY



NEW



DIMENSION	CODE
L 93 X W 53 X H 16 CM	1073893

NATURE LIQUOR AND WINE TROLLEY

WITH HANDLE

STRUCTURE IN 100% ITALIAN WALNUT HARDWOOD AND GALVANIZED ALUMINIUM LEGS
RACK WITH 3 INSULATED STAINLESS STEEL WINE COOLER
1 BIG GLASS HOLDER RACK
2 BOTTLE HOLDERS ON THE LOWER LEVEL FOR 6 BOTTLES
2 PROFESSIONAL SOFT CLOSING DRAWERS WITH 1 REMOVABLE SHELF FOR PLATES
1 BIG ALUMINIUM HANDLE
4 PROFESSIONAL MID-SOFT SWIVEL CASTORS ALL WITH BREAKS (Ø 125 MM)



NEW



DIMENSION	CODE
L 99.5 X W 53 X H 104 CM	1073894

NATURE COVERED CHILLED TOP

STRUCTURE IN 100% ITALIAN WALNUT HARDWOOD
STAINLESS STEEL 18/10 TRAY CHILLED WITH INCLUDED ICE PACK AND ROLL TOP
TOP & BASE TROLLEY 93 X 53 X H 109 CM
NATURE BASE TROLLEY 1066182 TO BE ORDERED SEPARATELY



NEW



DIMENSION	CODE
L 93 X W 53 X H 29 CM	1073891

NATURE CHAMPAGNE TOP

CHAMPAGNE BOWL INCLUDED
NATURE BASE TROLLEY 1066182 TO BE ORDERED SEPARATELY



NEW



DIMENSION	CODE
L 93 X W 53 X H 30 CM	1073892



NATURE WALNUT TROLLEYS

NATURE FLAMBE TROLLEY 1 BURNER

STRUCTURE IN 100% ITALIAN WALNUT HARDWOOD AND GALVANIZED ALUMINIUM LEGS
 GAS BURNER (BUTAN-PROPAN) WITH SAFETY VALVES
 NOMINAL POWER: 1,5 KW - CE CERTIFIED
 FLAME REGULATOR AND ELECTRIC IGNITION DEVICE (BATTERY)
 WORKSPACE IN STAINLESS STEEL
 1 BOTTLE HOLDER ON THE LOWER LEVEL FOR 3 BOTTLES
 1 PROFESSIONAL SOFT CLOSING DRAWER WITH 1 REMOVABLE SHELF FOR PLATES
 1 BIG ALUMINIUM HANDLE
 4 PROFESSIONAL MID-SOFT SWIVEL CASTORS ALL WITH BREAKS (Ø 125 MM)



DIMENSION	CODE
L 99.5 X W 53 X H 85 CM	1073895

NATURE TROLLEY 2 LEVELS

2 LEVELS STRUCTURE IN 100% ITALIAN WALNUT HARDWOOD AND GALVANIZED ALUMINIUM LEGS
 4 PROFESSIONAL MID-SOFT SWIVEL CASTORS ALL WITH BREAKS (Ø 125 MM)



DIMENSION	CODE
L 95.5 X W 53 X H 80 CM	1073897

NATURE PASTRY TROLLEY

4 LEVELS STRUCTURE IN 100% ITALIAN WALNUT HARDWOOD
 ROLL TOP (PMMA) WITH LOWER LEVEL WITH AUTOMATIC MOVEMENT
 LOWER LEVEL CHILLED WITH ICE PACK INCLUDED
 2 FOLDABLE PLATE HOLDER TRAYS IN STAINLESS STEEL 18/10
 2 BIG ALUMINIUM HANDLES
 4 PROFESSIONAL SWIVEL CASTORS ALL WITH BRAKES (Ø 125 MM)



DIMENSION	CODE
L 115 X W 52 X H 125 CM	1073896

WILLIAM BUFFET

4 CASTORS - 2 WITH BRAKE

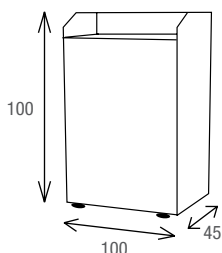

	COLOR	CODE
A	WENGE LOUISIANA	1074943
B	GREY BARDOLINO OAK	1074944
C	RUSTY CERAMIC	1074945
D	CONCRETE	1074946